

Wiring

Make wiring connections for the parts indicated by black lines in the connection diagram.

Operation with switching between high and low settings

Using a commercially available switch

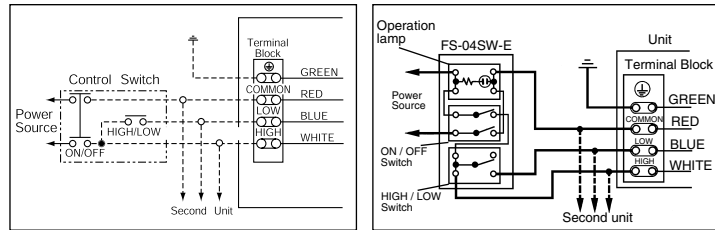

The operation for the FS-04SW-E control switch is designed to accommodate a cable with a diameter of 1.6mm or 2.0mm only.

Operation in the high or low setting only

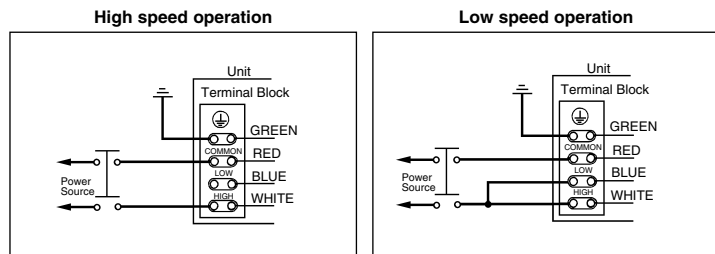

Trial Operation

When the installation work is complete, it is advised to re-check both the wiring and the fixing of the unit so that this product operates correctly with no vibration or noise.

Speed Adjustment and Angle Adjustment

If the wind outside affects the effectiveness of the Air Curtain, the following speed adjustments and angle adjustments are possible.

Condition	Adjustment method	Notes
No wind	Low setting, outflow direction straight down.	Confirm that the installation height and the standard barrier distance match.
Momentary gusts of wind	Outflow direction straight down. Operate at high setting during wind, and at low setting otherwise.	Be careful of the Air Curtain blowing air back inside when the high setting is selected.
Constant wind	Adjust the angle as described in the mounting section on page 9. Set the outflow direction toward the outside.	If the wind dies down, switch to the low setting or change the outflow direction to straight down.

After-Sales Service

Please contact the dealer from whom the unit was purchased concerning after-sales service.

Specifications

TYPE	Power Source		Air velocity maximum (m/s)	Noise dB (A)	Weight (kg)	Starting Current (A)	Maximum load current (A)
	Frequency	Voltage					
GK-2509YS1	50Hz	220-240	9.5	43-44.5	10.5	0.43	0.30
	60Hz	220	9.5	43			0.32
GK-2512AS1	50Hz	220-240	9.5	46-47	13.3	0.62	0.42
	60Hz	220	9.5	46.5			0.44
GK-3009AS1	50Hz	220-240	12	46-47	11	0.86	0.50
	60Hz	220	13	49.5			0.52
GK-3012AS1	50Hz	220-240	12	49-50	14	1.05	0.60
	60Hz	220	13	52			0.66

Cleaning

The Air Curtain should be cleaned when it gets dirty — roughly once every three months as a general rule. Also, be sure to clean and test run the Air Curtain before starting operation for the summer and winter seasons.

- Always switch power off before cleaning the unit.
- Never hang from the unit or push downward on it forcefully. A serious accident could result.
- Wear rubber gloves to avoid injuring your fingers.

Disassembling the Unit

If the power is located near the unit body, it is convenient to remove the unit body from the wall mounting plate for cleaning.

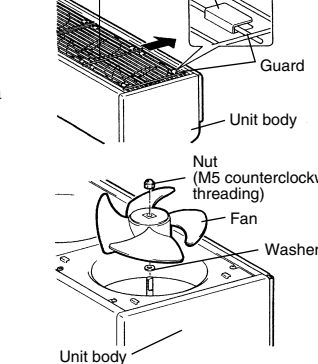

1. Remove the guard stopper screw and the washer. Then slide the guard toward the wall mounting plate as shown in the diagram and remove it from the hook. (The number of guards differs depending on the model.)
2. Remove the fan nut (M5 counterclockwise threading) and pull off the fan.

Note
• Note that the fan fits onto the shaft in a specific orientation.

Cleaning the Unit

Use a cloth dipped in neutral detergent to wipe away dirt from the system unit, guards, fans and ducts. Then wipe with a dry cloth to remove any remaining detergent.

- Note
- Do not use solvents such as the following to clean the unit: Paint thinner, alcohol, benzene, gasoline, kerosene, aerosol sprays, alkaline solvents or chemicals in chemically treated cleaning clothes. (Surface deterioration or discoloration could result.)

Reassembly and Inspection after Cleaning

When cleaning is finished, reverse the disassembly steps to reassemble the unit.

- Inspect the following items as you reassemble the unit.
1. The fan fits onto the shaft in a specific orientation. Be sure not to install it upside-down.
 2. Are there any scratches on the wiring inside the unit body?
 3. Have the unit body, washers, fans, nuts and guards all been mounted securely?
 4. Switch power on and confirm that the Air Curtain operates correctly.

MITSUBISHI ELECTRIC
AIR CURTAIN
GK-25 series
GK-30 series

OPERATING AND INSTALLATION INSTRUCTIONS

Be sure to read this instruction manual before starting installation work.

Installation work must be carried out by a dealer or a specialist installation contractor.

- Control switches are required to operate this unit.
- This is a single-phase product. Check the power supply before proceeding with the installation work.

Be sure to hand over these Operating and Installation Instructions to the user when the installation work has been completed.

- After reading this information, keep it in a place where any person using the product can refer to it at any time.

Essential Safety Precautions

Please be absolutely sure to read through the following information: it will help you to install the Air Curtain correctly and safely and to operate it properly. The precautions presented here contain important safety information: be sure to follow the applicable instructions given.

- Before proceeding with installation and operation, please be sure to read “Essential Safety Precautions” as it will tell you how to install and operate the product properly and safely.
- The displays have the following significance.

	WARNING	This applies to mishandling or misoperation of the product which may lead to a fatal or serious injury.
	CAUTION	This applies to mishandling or misoperation of the product which will lead to injury or damage to your home, household effects, etc.

	Prohibited		Use is prohibited wherever water is present.		You must follow the instructions given.		Beware of rotating objects.
	Do NOT disassemble.		Do NOT touch.		Connect the grounding wire.		

WARNINGS	
	• Do not touch the moving parts. (You may injure yourself.)
	• Do not poke your fingers or any objects into the air outlet openings or moving parts during operation since this is dangerous. (You may injure yourself.)
	• If operation stops while the power is still switched on, do not touch the product under any circumstances. (There is a danger that the unit could suddenly start operating again and cause injury. There is also a danger of electrical shock.)
	• DO not attempt remodelling under any circumstances. Disassembly and repair are permitted only by qualified repair engineers. (The product may cause fire, electrical shock and/or injury.) For repairs, please contact the dealer from whom the unit was purchased or a Mitsubishi Electric Corporation customer service center.
	• Do not apply water to the product or splash water onto it. (Short-circuiting or electrical shock may be caused.)
	• Do not use the product where the combustion area of its combustion device will be directly exposed to wind or air movement. (This may cause incomplete combustion or result in the flames being extinguished leading to carbon monoxide poisoning.)
	• When passing the product and metal ducts connected to the product through wooden buildings lined or covered with metal or wire laths or with metal sheets, install the product and ducts in such a way that they will not make electrical contact with the metal or wire laths or metal sheets. (Ignition may occur if there are power leaks.)
	• Before proceeding with maintenance work, be absolutely sure to set the circuit-breaker on the power board to the OFF position. In addition, do not perform the work with wet hands. (Electrical shock or injury may result.)
	• Ground the product properly. (Electrical shock may be caused in case of malfunctioning or power leaks.)

CAUTIONS	
	• Do not use this product outside its rated voltage and power line frequency ranges. (Fire or electrical shock may be caused.)
	• Do not hang on the product or swing from it. (It may fall, resulting in injury.)
	• Never use the product in a bathroom or other location with excessive moisture (more than 90% RH). (Electrical shock or fire may be caused.)
	• When installing the main unit, select a location which is sufficiently strong, and install the unit securely. (Failure to do so may result in the parts falling, resulting in injury.)
	• Install the parts properly and securely. (Failure to do so may result in the parts falling, resulting in injury.)
	• Wiring work should be performed safely and reliably, and in accordance with applicable electrical equipment technical standards and internal wiring standards. (Poor connections or errors in the wiring work could result in electrical shock or fire.)
	• If more than one unit is to be operated at the same time, ensure that the combined current value flowing through the terminal panel to which the units are connected does not exceed 5A. (Failure to observe this precaution could result in electrical shock or fire.)
	• If the product is not going to be used for a prolonged period of time, be absolutely sure to set the circuit-breaker on the power board to the OFF position. (Deterioration in the insulation may cause electrical shock, power leaks or fire.)

Notes	
	• The digits in the model number indicate the standard barrier distance and installation width. (In the case of the GK-2509YS1, the standard barrier distance is 2.5 m and the installation width is 90 cm.) The Air Curtain will not be effective if the air flow is too weak or if it is too strong. Make sure to confirm the installation height and the model.
	• When installing the Air Curtain at the entrance to a store or office, the air outlet opening should be oriented toward the inside. However, it may be oriented toward the outside provided that the unit is installed under eaves or an awning that prevents rain from falling on it and there is no danger of rain being sucked into the intake opening. Also, the unit must be installed outside if it is to be mounted on a freezer room.
	• If the unit will be recessed in the ceiling, be sure to provide an inspection opening (with an opening at least 450 mm wide) in the ceiling to allow for maintenance inspections.
	• Should a power failure occur, be sure to turn the unit's power switch off. (Otherwise, there is a danger that a malfunction could occur if the unit's fan suddenly starts to turn when power is restored.)
	• Use a motor circuit breaker or the like with the wiring system.

Description of Functions

- The unit is equipped with overheating prevention device (thermal fuse) to prevent overheating of the motors and resistors. During abnormal conditions, such as if the ambient temperature is unusually high, if an overload occurs, if a phase interruption occurs during operation, or if operation is restricted in some way, the fuse will burn out, preventing power from being supplied to the unit. Should this occur, the unit cannot be restarted. Should the power be cut off while the unit is operating, perform the steps below before restarting the unit.
Treatment:
It is necessary to switch off the power supply, remedy the cause of the problem, and replace the motors, capacitors, and resistors. (The GK-2509YS1 and GK-3009AS1 have two different types of motors. Take care to replace the motors with the correct type.)
Also, if the portion of the unit where the motors and resistors are mounted has become malformed or is otherwise abnormal, the mounting should be replaced as well. Contact a specialist contractor to perform the replacement.

External Dimensional Diagram

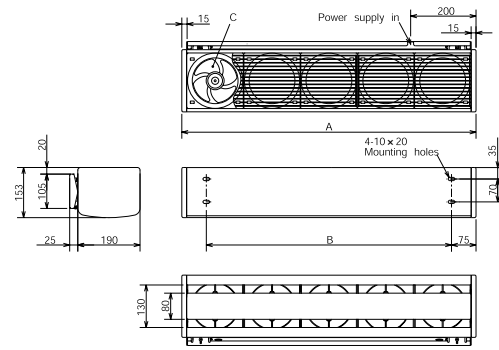

Accessories

Wall mounting plate: 1
Washers: (large/small): 4 each
Wood screws: 4
Spring washers: 4
Nuts (M8): 4

System parts

• Please refer to product catalog.

Ceiling bracket FS-04SW-E Control Switch

Table of dimension changes

TYPE	A	B	C (Number of fans)
GK-2509YS _i	900	750	5
GK-2512AS _i	1194	1044	6
GK-3009AS _i	900	750	5
GK-3012AS _i	1194	1044	6

Mounting Method

Mounting locations and surfaces differ, but in any case make sure that the unit is mounted sufficiently securely and that it is level.

Mounting examples

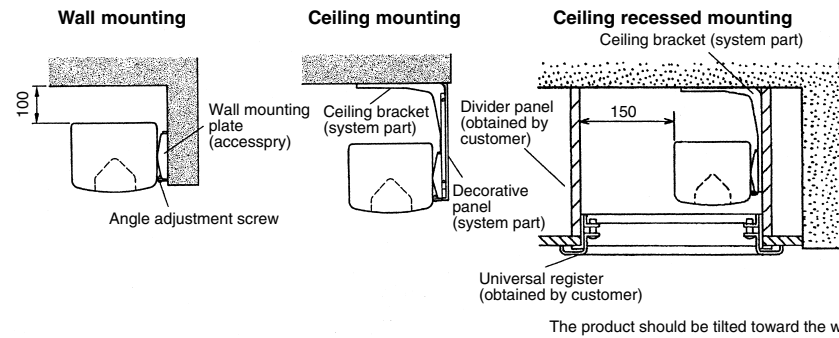

Notes

- An open space of at least 100 mm must be provided at the Air Curtain's intake opening. Otherwise, the Air Curtain will not provide sufficient barrier performance.
- If there is a wall to the side of the Air Curtain, there must be a gap of at least 17 mm between the wall mounting plate and the wall. Otherwise, the body of the unit will bump into the wall and it will not be possible to mount it.
- If multiple units are to be installed side by side, there must be a gap of at least 34 mm between the wall mounting plates.

Preparations Before Mounting

■ Concrete walls, steel frame, steel pillars

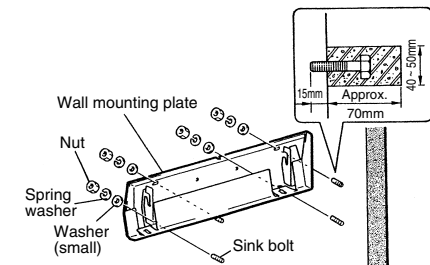

1. Sink the sink bolt into the wall so that it extends approximately 15 mm from the surface of the wall.
2. Remove the (two) angle adjustment screws that are temporarily secured to the protruding portion at the bottom of the unit body. Remove the wall mounting plate from the unit body.
3. Secure the wall mounting plate in place using the washers (small), spring washers, and nuts included with it.

■ Panel wall

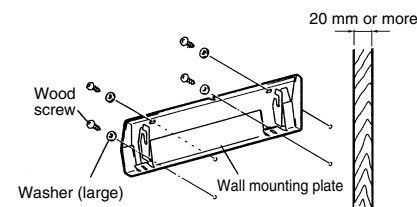

- If the panel is 20 mm thick or more, secure the wall mounting plate in place directly using the supplied wood screws and washers (large).
- If the panel is less than 20 mm thick, mount a reinforcing panel (obtained by the customer) that will make it 20 mm thick or more.

■ Using Ceiling Brackets (System Parts)

Secure the ceiling brackets in place using a mounting method appropriate to the material and structure of the ceiling.

1. Refer to the table below regarding the mounting method for ceiling brackets.

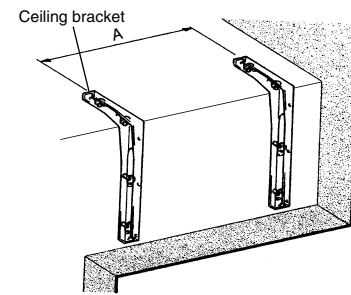

TYPE	Number used	A	Product weight (kg)
GK-2509YS _i	2	750	10.5
GK-2512AS _i	2	1044	13.3
GK-3009AS _i	2	750	11.0
GK-3012AS _i	2	1044	14.0

Notes

- If there is a wall to the side of the Air Curtain, the ceiling brackets must be at least 78 mm from the wall. Otherwise, it will not be possible to mount the Air Curtain.
- If multiple Air Curtains are mounted side by side, the gap between one Air Curtain's ceiling brackets and those of the next must be at least 156 mm.
- Be sure to use the correct number of ceiling brackets, as specified above.

■ Using a Decorative Panel (Provided by Customer)

If the customer supplies decorative panels, the installation will be even more attractive.

2. Mount a decorative panel on the ceiling brackets:

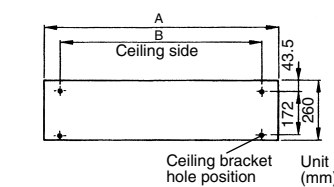
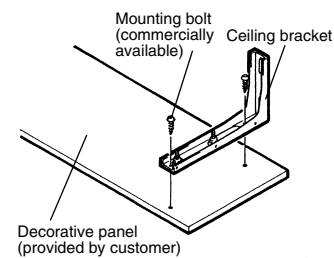

1. Cut the decorative panels to the dimensions indicated in the diagram at left.
2. Secure the decorative panel to the ceiling brackets using commercially available mounting screws screwed into all of the mounting holes (4.5 mm diameter) in the ceiling brackets.

Note

- The decorative panel should not weigh more than 6 kg.

TYPE	A	B
GK-2509YS _i : GK-3009AS _i	904	75
GK-2512AS _i : GK-3012AS _i	1198	1044

3. Secure the ceiling brackets to the ceiling:

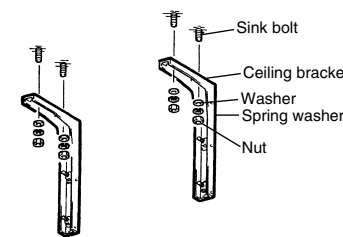

4. Secure the supplied wall mounting plate to the Air Curtain:

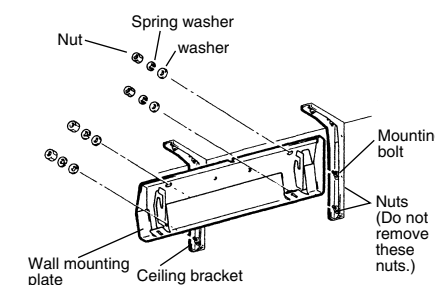

- Remove the nuts, spring washers, and washers attached to the ceiling brackets, pass the mounting bolts through the mounting holes in the wall mounting plate, and then secure the wall mounting plate in place using the washers, spring washers, and nuts that had been removed.

■ Installing the Air Curtain vertically

The product may be installed vertically. Take care regarding the orientation of the unit body and follow the instructions for wall mounting.

Mounting the Unit Body

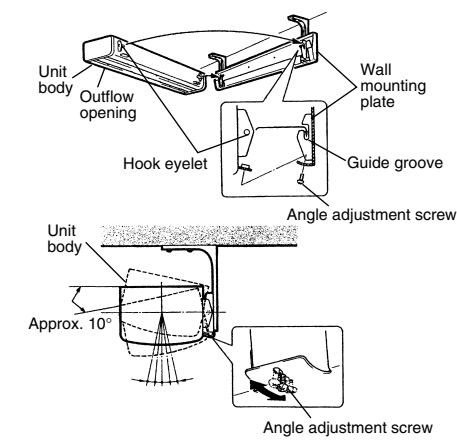

Notes

- Align the screw holes on the unit body with the angle of the angle adjustment screws and then tighten them. Otherwise the screw heads could be crushed, making adjustment impossible.

Electrical Work

- Electrical work should be performed by a contractor specializing in this type of work.
- Power supply cables with a capacity appropriate to the current value of the Air Curtain (or, if multiple units are used, the total current of the Air Curtains) should be used for the electrical lines.
- This unit requires the use of a control switch.
- A switch of the configuration shown in the figure below, or the optional FS-04SW-E control switch is necessary if speed adjustment is required. This switch must have a minimum contact separation of 3 mm in all poles.

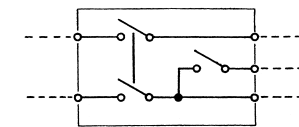

- A power ON/OFF switch (2-pole) is required for operation at high/low speed.
- When selecting a motor circuit breaker, use a value of 1.2 to 1.5 times that of the maximum load current listed in the specifications as a rule of thumb.

■ Selecting a magnetic contact

- The contact capacity should be greater than the total operating current of all the connected Air Curtain units, and the operation coil current should not exceed 15A (switch capacity).

■ Operating Multiple Units

- The total current value for the product's terminal panel should not exceed 5 A.

■ Wiring method

1. Mount the round contact terminals onto the end of the power cord.
2. Remove the cover of the terminal panel, which is screwed onto the unit body.
3. Connect the power cord to the terminal panel.
4. Screw the cover of the terminal panel (which was removed earlier) back on.

