

Air-conditioner Control System

Advanced Touch Controller AT-50B

Installation Manual



For distribution to dealers and contractors

Chapter 1. Installation

Thoroughly read the following safety precautions prior to installation. Refer to Chapter 2. "Initial Setting" in this manual, and the Instruction Book for information on operating or making the settings for the controller. Also, refer to the air conditioning unit installation manuals for how to connect cables or how to install air conditioning units.

1-1. Safety Precautions

- Thoroughly read the following safety precautions prior to installation.
- Observe the following precautions to ensure safety.

 WARNING	Indicates a risk of death or serious injury.
 CAUTION	Indicates a risk of serious injury or structural damage.

- Nomenclature



(Prohibited actions)



(Do not touch)



(No water)



(No wet hands)



(Fire hazards)



(Electric shock hazards)



(Injury hazards)



(Important actions)



(Grounding required)

- After reading this manual, pass it on to the end user to retain for future reference.
- Keep this manual for future reference and refer to it as necessary. This manual should be made available to those who repair or relocate the controller. Make sure that the manual is passed on to any future AT-50B users.

All electric work must be performed by qualified personnel.

General precautions

WARNING

Do not install the unit in a place where large amounts of oil, steam, organic solvents, or corrosive gases, such as sulfuric gas, are present or where acidic/alkaline solutions or sprays are used frequently. These substances can compromise the performance of the unit or cause certain components of the unit to corrode, which can result in electric shock, malfunctions, smoke, or fire. 

To reduce the risk of shorting, current leakage, electric shock, malfunctions, smoke, or fire, do not wash the controller with water or any other liquid. 

To reduce the risk of electric shock, malfunctions, smoke or fire, do not operate the switches/buttons or touch other electrical parts with wet hands. 

To reduce the risk of injury or electric shock, before spraying a chemical around the controller, stop the operation and cover the controller. 

To reduce the risk of injury or electric shock, stop the operation and switch off the power supply before cleaning, maintaining, or inspecting the controller. 

Properly install all required covers to keep moisture and dust out of the controller. Dust accumulation and water can cause electric shock, smoke, or fire. 

To reduce the risk of injury, keep children away while installing, inspecting, or repairing the controller. 

CAUTION

To reduce the risk of fire or explosion, do not place flammable materials or use flammable sprays around the controller. 

To reduce the risk of damage to the controller, do not directly spray insecticide or other flammable sprays on the controller. 

To reduce the risk of electric shock or malfunctions, do not touch the touch panel, switches, or buttons with a pointy or sharp object. 

To reduce the risk of injury and electric shock, avoid contact with sharp edges of certain parts. 

To avoid injury from broken glass, do not apply excessive force on the glass parts. 

To reduce the risk of injury, wear protective gear when working on the controller. 

Precautions during installation

WARNING

Do not install the controller where there is a risk of leaking flammable gas. If flammable gas accumulates around the controller, it may ignite and cause a fire or explosion. 

Properly dispose of the packing materials. Plastic bags pose suffocation hazard to children. 

Take appropriate safety measures against earthquakes to prevent the controller from causing injury. 

To prevent injury, install the controller on a flat surface strong enough to support its weight. 

CAUTION

To reduce the risk of shorting, current leakage, electric shock, malfunctions, smoke, or fire, do not install the controller in a place exposed to water or in a condensing environment. 

Controller must be installed by qualified personnel according to the instructions detailed in the Installation Manual. Improper installation may result in electric shock or fire. 

Precautions during wiring

WARNING

To reduce the risk of damage to the controller, malfunctions, smoke, or fire, do not connect the power cable to the signal terminal block. 

Properly secure the cables in place and provide adequate slack in the cables so as not to stress the terminals. Improperly connected cables may break, overheat, and cause smoke or fire. 

To reduce the risk of injury or electric shock, switch off the main power before performing electrical work. 

All electric work must be performed by a qualified electrician according to the local regulations, standards, and the instructions detailed in the Installation Manual. Capacity shortage to the power supply circuit or improper installation may result in malfunction, electric shock, smoke, or fire. 

To reduce the risk of electric shock, install a breaker and a residual current circuit breaker on the power supply. To reduce the risk of electric shock, smoke, or fire, install a breaker for each controller. 

Use properly rated breakers and fuses (breaker, local switch <switch + fuse>, no-fuse breaker). The use of a breaker with a breaking capacity greater than the specified capacity may cause electric shock, malfunctions, smoke, or fire. 

To reduce the risk of current leakage, overheating, smoke, or fire, use properly rated cables with adequate current carrying capacity. 

Proper grounding must be provided by a licensed electrician. Do not connect the grounding wire to a gas pipe, water pipe, lightning rod, or telephone wire. Improper grounding may result in electric shock, smoke, fire, or malfunction due to electrical noise interference. 

CAUTION

To reduce the risk of electric shock, shorting, or malfunctions, keep wire pieces and sheath shavings out of the terminal block. 

To reduce the risk of shorting, current leakage, electric shock, or malfunctions, keep the cables out of contact with controller edges. 

To reduce the risk of electric shock, malfunctions, or fire, seal the gap between the cables and cable access holes with putty. 

Precautions for moving or repairing the controller

WARNING

The controller should be repaired or moved only by qualified personnel. Do not disassemble or modify the controller. Improper installation or repair may cause injury, electric shock, or fire. 

CAUTION

To reduce the risk of shorting, electric shock, fire, or malfunction, do not touch the circuit board with tools or with your hands, and do not allow dust to accumulate on the circuit board. 

Additional precautions

To avoid damage to the controller, use appropriate tools to install, inspect, or repair the controller.

AT-50B is designed for exclusive use with the Building Management System by Mitsubishi Electric. The use of this controller for with other systems or for other purposes may cause malfunctions.

Take appropriate measures against electrical noise interference when installing the air conditioners in hospitals or facilities with radio communication capabilities. Inverter, high-frequency medical, or wireless communication equipment as well as power generators may cause the air conditioning system to malfunction. Air conditioning system may also adversely affect the operation of these types of equipment by creating electrical noise.

To avoid malfunctions, do not bundle power cables and signal cables together, or place them in the same metallic conduit.

To avoid damage to the controller, do not overtighten the screws.

To avoid discoloration, do not use benzene, thinner, or chemical rag to clean the controller. To clean the controller, wipe with a soft cloth soaked in water with mild detergent, wipe off the detergent with a wet cloth, and wipe off water with a dry cloth.

To avoid damage to the controller, provide protection against static electricity.

Do not use solderless terminals to connect cables to the terminal block. Solderless terminals may come in contact with the circuit board and cause malfunctions or damage the controller cover.

To avoid damage to the controller, do not make holes on the controller cover.

To avoid deformation and malfunction, do not install the remote controller in direct sunlight or where the ambient temperature may exceed 40°C (104°F) or drop below 0°C (32°F).

1-2. The CD-ROM that is supplied with AT-50B

WARNING

The CD-ROM that is supplied with the Remote Controller can only be played on a CD-drive or a DVD-drive. Do not attempt to play this CD-ROM on an audio CD player as this may damage your ears and/or speakers.

The CD-ROM that is supplied with AT-50B has Installation Manual and Instruction Book in English, German, French, Spanish, Italian, Portuguese, Russian, Swedish, simplified Chinese, and traditional Chinese.

Each document is in PDF format.

Viewing documents requires a computer with Adobe Reader or Adobe Acrobat installed.

“Adobe Reader” and “Adobe Acrobat” are registered trademarks of Adobe Systems Incorporated.

1-3. Parts list

The package contains the following parts.

Parts		Qty.
1.	AT-50B	1
2.	Mounting bracket	1
3.	M4.1 wood screws × 16 (5/8 in) *1 (Use to attach the mounting bracket to a wall.)	4
4.	M4 Roundhead cross slot screws × 30 (1-3/16 in) *1 (Use to attach the mounting bracket to an electric box.)	4
5.	M4 roundhead screws with spring washers/washers × 20 (25/32 in) (Use to attach the mounting bracket to the controller.) *1	2
6.	Installation Manual (This manual)	1
7.	Instruction Book	1
8.	CD-ROM (Instruction Book, Installation Manual)	1

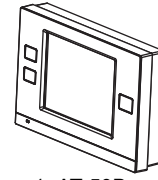

1. AT-50B

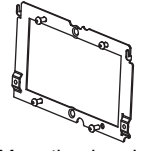

2. Mounting bracket

*1 ISO metric screw thread

1-4. Product specifications

1. Specifications

Power source	30VDC *1 (for connection to M-NET only)	Receives power from the power supply unit for transmission line or from outdoor units via the M-NET transmission cable. The power consumption coefficient*2 of AT-50B is "4."
Operating conditions	Temperature	Operating temperature range 0°C~40°C [32°F~104°F] Storage temperature range -20°C~+70°C [-4°F~+158°F]
	Humidity	30%~90%RH (Non-condensing)
Weight	0.5 kg [1-1/8 lbs.]	
External dimensions (W x H x D)	180 x 120 x 30 mm 7-3/32 x 4-23/32 x 1-3/16 in	

*1 Not for use with a generic DC power supply device. Use the power supply unit for transmission line (PAC-SC51KUA etc.) by Mitsubishi.

*2 "Power consumption Coefficient" is a coefficient to calculate the relative power consumption of the devices that receive power through the M-NET transmission line. Refer to the note at the end of section 1-5 "System diagram."

2. Unit Components and Functions

Front (with the cover on)

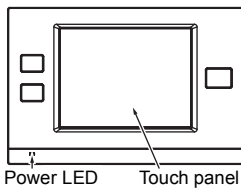

Front (cover off)

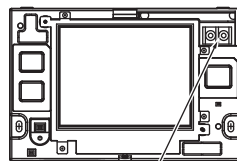

For connection to the M-NET
(A, B: Terminal for connection to the M-NET cable [non-polarized])

Back

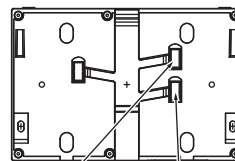

External input adapter cable access hole
External output adapter cable access hole

Bottom

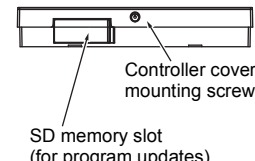

Controller cover mounting screw
SD memory slot (for program updates)

1-5. System diagram

1. System configuration

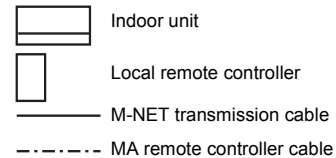
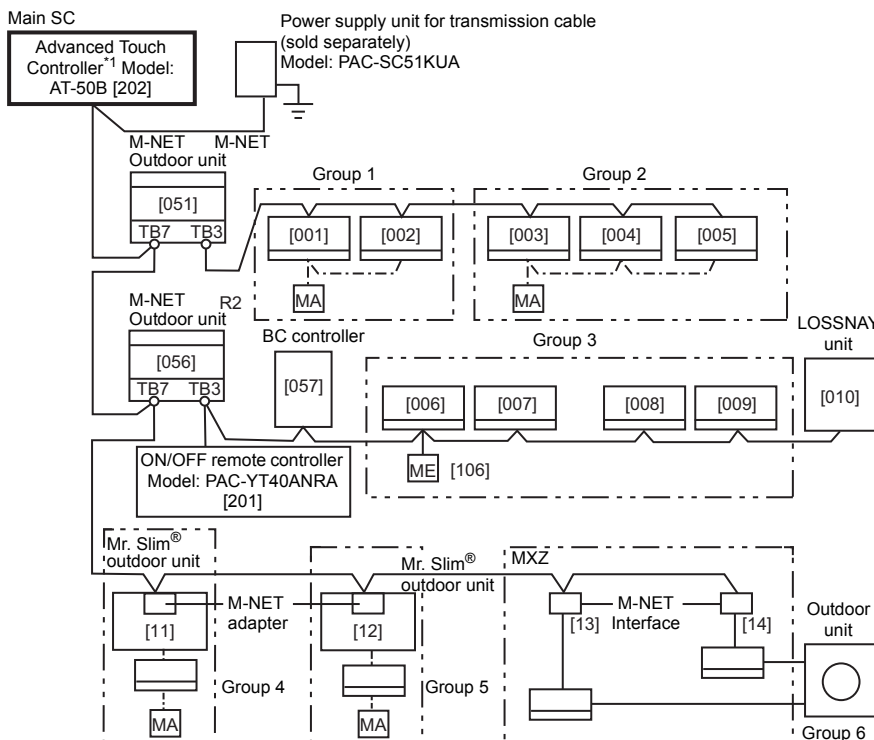

Numbers in the parentheses indicate address numbers.

Note:

- The figure at left only shows the transmission line connections. Power supply lines are omitted.
- Provide a single ground point (class D) by grounding the shield wire of the M-NET centralized controller transmission cable at one of the power supply units. Provide a ground point for the indoor-outdoor transmission cable for each outdoor unit.
- Make sure that the centralized control switch (SW2-1, or SW5-1 on some models) on the outdoor unit connected to the M-NET cable is set to ON.
(Refer to the outdoor unit Installation Manual for detailed information about dip switch settings.)
- When both Air To Water (PWFY) and air-conditioning units are connected to the outdoor unit of Y series, the functions of Setback, System-Changeover, and Operation Mode Selection Limit do not work properly.

*1 The power consumption coefficient of AT-50B is 4 and that of an indoor unit is "1", which means that each AT-50B unit consumes power equivalent to four indoor units. (*Indoor units receive power through the M-NET transmission line to maintain communication during power failure.) Refer to the CITY MULTI DATABOOK for details. The total power consumption of the connected devices should not exceed the capacity of the power supply units. The Design Tool by MITSUBISHI ELECTRIC allows its user to design air conditioning systems easily. AT-50B is compatible with the Design Tool version 4.61 or later. AT-50B can be connected to either TB7 or TB3. When connected to TB3, no power supply units are required.

- Address settings (Address overlaps are not allowed.)

	Address setting	Address range
Indoor unit	Assign the lowest address to the main indoor unit in the group, and assign sequential addresses to the rest of the indoor units in the same group. Note: The following models require two addresses: PEFY-AF1200CFM and PEFY-AF1200CFM-R	1~50
Outdoor unit	Assign an address that equals the lowest indoor unit address in the same refrigerant system plus 50.	51~100
Auxiliary outdoor unit (BC controller)	Assign an address that equals the address of the outdoor unit in the same refrigerant system plus 1.	52~100
LOSSNAY unit	Assign an arbitrary but unused address to each LOSSNAY unit after assigning an address to all indoor units.	1~50
Mr. Slim® unit	Same rules as for the indoor units apply. An M-NET adapter (sold separately) is required.	1~50
MXZ unit	Same rules as for the indoor units apply. An M-NET interface (sold separately) is required.	1~50
M-NET remote controller	Assign an address that equals the address of the main indoor unit with the lowest address in the group plus 100. Add 150 instead of 100 to set a sub-remote controller.	101~200
Sub system controller	Assign an address that equals the lowest number of the group to be controlled plus 200.	201~250
DIDO (PAC-YG66DCA)	Assign an arbitrary but unused address to the controller after completing the address setting for the units with an address between 1 and 50. The number of controllable units depends on the number of channels used. (1 channel = 1 unit)	1~50
MA remote controller	Address setting is not required. The connection of two remote controllers requires the main/sub setting for each controller to be made.	-
Air To Water (PWFY)*	Assign the lowest address to the main Air To Water (PWFY) in the group, and assign sequential addresses to the rest of the Air To Water (PWFY) in the same group.	1~50

* "Booster unit" and "Water HEX unit" are referred to as "Air To Water (PWFY)".

*AHC (Advanced HVAC CONTROLLER) cannot be controlled from AT-50B.

Note

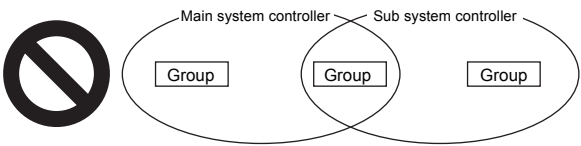
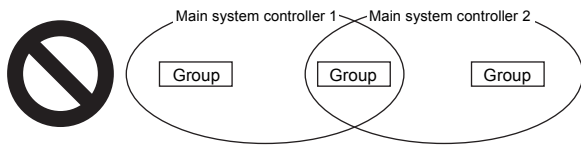
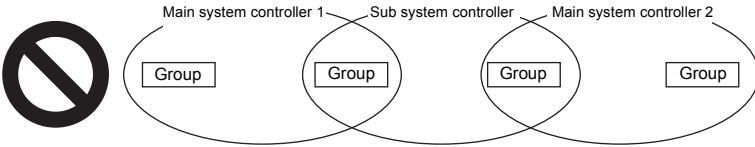
- The system cannot be configured as shown in the examples below.
 - ▶ Groups that are not controlled by a main controller cannot be controlled from a sub controller.
 
 - ▶ Each group cannot be controlled by two or more main controllers.
 
 - ▶ Sub controllers cannot be controlled by two or more main controllers.
 

2. M-NET wiring design

(1) M-NET transmission cable specifications and restrictions

Cable Specifications	Facility type	All facility types
	Type	Shielded cable CVVS · CPEVS · MVVS
	No. of cores	2-core
	Size	CVVS, MVVS: 1.25 mm ² (AWG16) or larger CPEVS: ø1.2 mm (AWG16 or its equivalent) or larger
Maximum indoor-outdoor transmission cable length		200 m [656 ft]
Maximum length of transmission line for centralized control and indoor-outdoor transmission cables (Maximum cable distance via outdoor unit)		500 m [1640 ft] *The maximum cable distance from the power supply unit to each outdoor unit or to the system controller is 200 m [656 ft].

The figure below shows the M-NET transmission wiring diagram for City Multi air conditioners.

The maximum length of centralized control M-NET transmission line and the indoor-outdoor transmission line per system can be expressed in the following formulas. Labels "a through g" represent the sections of wiring in the system in the figure below. These limits ensure normal signal communication over the M-NET transmission line.

If the line length exceeds the maximum length, M-NET signal attenuation can occur, rendering normal communication and control impossible.

$$a+b+d+e(f) \leq 500 \text{ m (1640 ft)} \quad a+b+c+g \leq 500 \text{ m (1640 ft)} \quad e(f)+d+c+g \leq 500 \text{ m (1640 ft)}$$

The maximum length of local remote controller cable is 10 m (32 ft). The length that exceeds 10 m (32 ft) must be included in the maximum total line length 500 m (1640 ft).

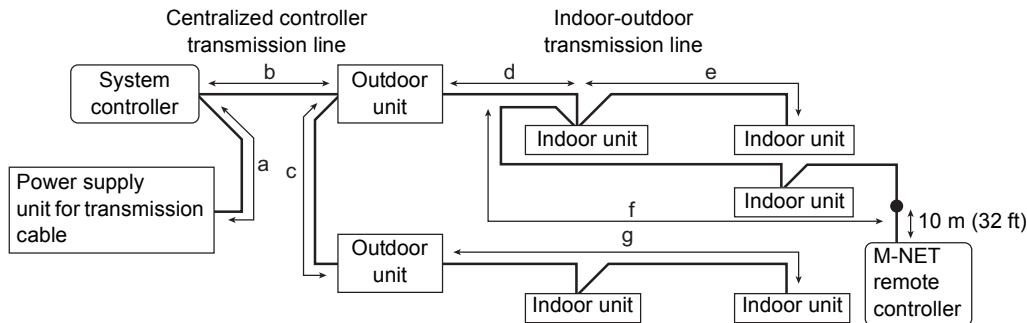

1-6. Installation

1. Field-supplied parts

The following parts are required to install the controller.

Parts	Qty.	Note
Triple electric box	1	Not required for wall-surface installation
Thin metal conduit	As appropriate	
Lock nut and bushing	As appropriate	
M-NET cable	As appropriate	Shielded cable CVVS, MVVS: 1.25 mm ² ~2 mm ² (AWG16~14) CPEVS: ø1.2 mm~ø1.6 mm (AWG16~14 or their equivalents)

2. Required tools

- A knife or nippers
- Crosshead driver

3. Installation methods

Follow the instructions provided for the selected installation option.

- (a) Wall-embedded installation using an electric box
- (b) Wall-surface installation
 - (b-1) To route the cable through the wall
 - (b-2) To route the cable along the wall surface

4. Preparation

- (1) Install a breaker on the power supply unit side before installing the controller.
- (2) Select an installation site for the AT-50B.

- Install the controller at the user's eye level for easy operation.
- Ensure there is enough clearance space as shown in the figure at right.
- Ensure there is enough clearance space to allow for easy access to the panel and the buttons.

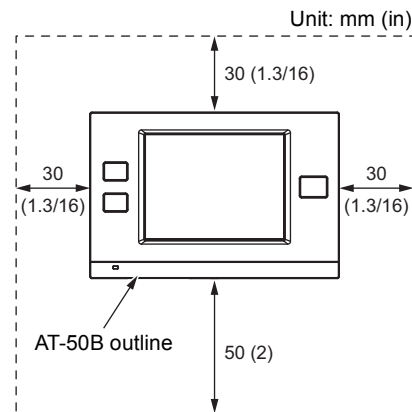

Note

Refer to section 1-7 "Using external input/output" for how to connect external input/output signal cables.

Note

Do not push the shield wire into or connect it to the AT-50B. Trim the shield wire, cover it with vinyl insulating tape, and leave it outside the controller.

- (3) Bring the cable end up to the controller.

Ensure the M-NET transmission cables and external input/output cables are long enough to reach the controller. Have extra cables to extend these cables as necessary.

- To install the controller according to the instructions provided in sections (a) and (b-1) above Include an extra 30 cm (12 in) of cable to provide adequate slack in the cable. Remove the sheath on the M-NET transmission cable up to 20 cm (8 in) from the end.
- To install the controller according to the instructions provided in section (b-2) above Include an extra 15 cm (6 in) of cable to provide adequate slack in the cable. Remove the sheath on the M-NET transmission cable up to 10 cm (4 in) from the end.

- (4) Prepare the AT-50B.

Unscrew the screw at the bottom of the controller, and remove the cover.

To route the cable along the wall surface, cut out the rectangle knockout hole (18 mm (W) x 9 mm (D)) at the top of the controller with a knife or a nipper (shown as the shaded area in the figure below at right).

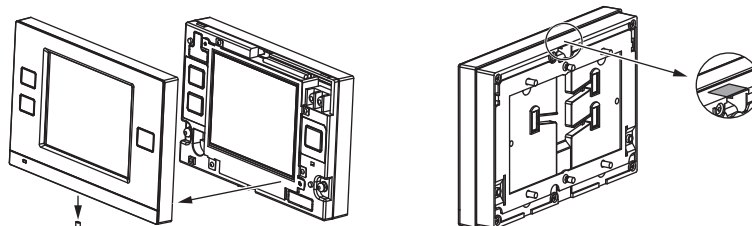

5. Installation steps

(1) Routing the cables

(a) Wall-embedded installation using an electric box

Pull the M-NET transmission cable through the hole on the wall and the electric box, and seal the gap between the cable and the end of the conduit tube with putty.

(b) Wall-surface installation

- To route the cable through the wall:
Drill a hole in the wall, push the M-NET transmission cable through the hole, and seal the gap between the cable and the hole with putty.
- To route the cable along the wall surface:
It is approximately 10 cm (4 in) from the cable access hole on the back of AT-50B to the M-NET terminal block. Trim off the excess transmission cable, if any.

To reduce the risk of electric shock, malfunctions, or fire, seal the gap between the cables and access holes with putty.

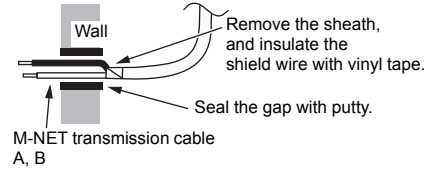
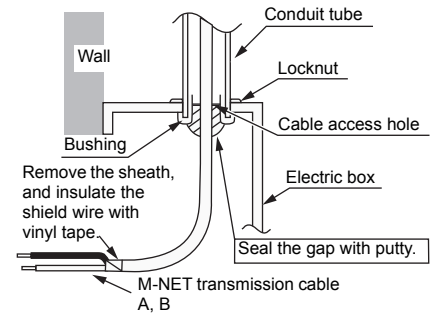

(2) Attach the mounting bracket on the wall.

Attach the mounting bracket on the designated area on the wall using the supplied screws. The pitch for the mounting bracket is shown in the figure at right.

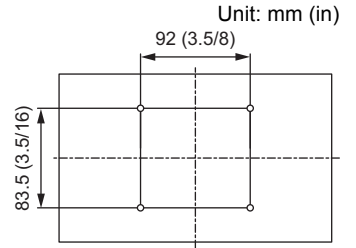

(3) Attach the controller to the mounting bracket.

After inserting the M-NET transmission cables (A and B) through the cable access hole on the controller from the back, hang the controller on the hooks of the mounting bracket. Attach the controller to the mounting bracket using twenty M4 screws with spring washers/washers.

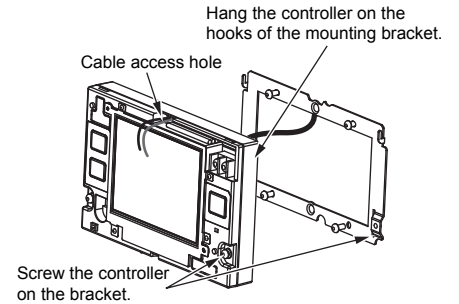

(4) Connect the cables.

Connect the M-NET transmission cables (A and B) to the terminal block. M-NET transmission cable is non-polarized. Insert the cables in the groove on the controller so they will not be pinched when the cover is installed.

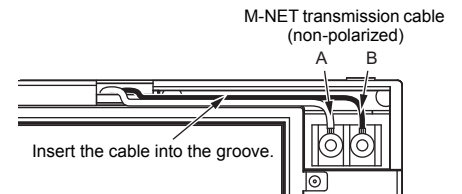

Note

- The M-NET terminal on the controller is only for connection to the M-NET cable. Do not connect an AC power supply.**
- Do not daisy-chain M-NET terminals.**

*To route the cable along the wall surface

Secure the cables in place with a cable cover, and seal the gap between the cable cover and the controller with putty.

To reduce the risk of electric shock, malfunctions, or fire, seal the gap between the cables and access holes with putty.



(5) Replace the cover.

Snap the cover into place, and attach it to the controller with a screw at the bottom.

*Tighten the screw to a torque of 10 N·m or less.

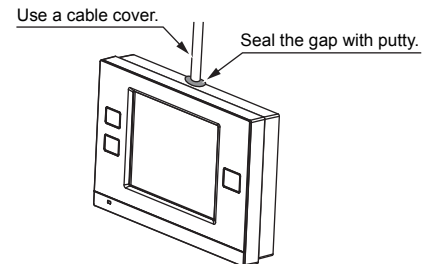

1-7. Using external input/output

1. External signal input (CN2)

*To use external input, an external input/output adapter (PAC-YT41HAA; sold separately) is required.

(1) External input

Using external dry contact signals, the following operation of all air conditioning units can be controlled from the AT-50B: Emergency stop/Normal operation, ON/OFF, Permit/Prohibit local remote controller operation. These settings are made on the External Input Settings on the Initial Settings screen that is accessible from the Service Menu screen. (Refer to section 2-3.)

Mode	External input signal setting	Notes
1	Do not use external input. (Factory setting)	—
2	Emergency stop/Normal operation signal (level signal)	When the units are not operating after receiving an emergency stop signal, the ON/OFF operation from the local remote controller will not be allowed, and the ON/OFF and Prohibit/Permit settings on the AT-50B cannot be changed. Timer operation will not function.
3	ON/OFF signal (level signal)	ON/OFF operation from the local remote controller will not be allowed, and the ON/OFF and Prohibit/Permit settings on the AT-50B cannot be changed. Timer operation will not function.
4	ON/OFF and Prohibit/Permit remote controller operation signal (pulse signal)	The ON-signal pulse width should be set to a value between 0.2 and 1 seconds.

(2) Level signal and pulse signal

(A) Level signal

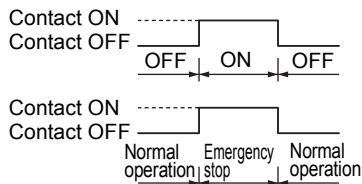

(B) Pulse signal

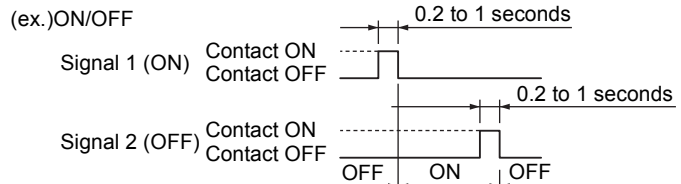

*Same for Prohibit/Permit remote controller operation.

(3) External input specifications

CN2	Lead wire	Emergency stop/Normal operation signal (level signal)	ON/OFF level signal	ON/OFF, Prohibit/Permit remote controller operation (pulse signal)
1	Green	Built-in 5 VDC power for external input * Exclusively for use with external input. Not usable for other purposes.		
2	Yellow	Emergency stop/Normal operation signal input	ON/OFF signal input	ON signal input
3	Orange	Not used	Not used	OFF signal input
4	Red	Not used	Not used	Prohibit-local-remote-controller-operation signal input
5	Brown	Not used	Not used	Permit-local-remote-controller-operation signal input

(A) Level signal

- If the type of signal assigned to the external input contact is "Emergency/Normal," the units in normal operation will stop when the signal input changes from OFF to ON. Conversely, the units that are stopped will resume normal operation when the signal changes from ON to OFF. After the emergency stop is reset, the original operating status of each air conditioning unit will not be automatically restored. The air conditioning units must be started up manually.
- If the type of signal assigned to the external input contact is "ON/OFF," the units that are stopped will start operation after the input signal changes from OFF to ON. Conversely, the units that are in operation will stop after the input signal changes from ON to OFF.

(B) Pulse signal

- If the incoming signal is the same as the signal that is currently being received, no status change will occur.
- If local remote controller operation is prohibited, ON/OFF, operation mode, set temperature, filter sign reset, fan speed, and air direction settings will be prohibited, and also timer (schedule) settings from the local remote controllers will be deactivated. Depending on the models of the connected air conditioning units and remote controllers, operation of some of the items above may not be disabled.
- The ON-signal pulse width should be set to a value between 0.2 and 1 seconds.

(4) Sample circuit recommended

(A) Level signal

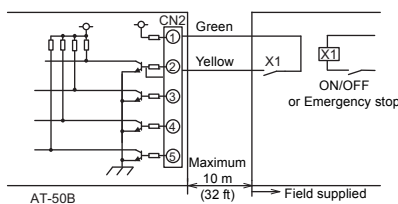

(B) Pulse signal

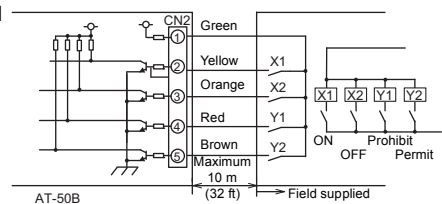

- The relays and extension cables are field supplied.
- Use a no-voltage contact and minute load relay (minimum application load 5VDC-1mA).
- The length of the connection cable extension should not exceed 10 m (32 ft). (Use a cable of 0.3 mm² (22AWG) or thicker.)
- Insulate the area with vinyl tape where the controller cable and the extension cable are connected.
- Insulate the end of unused lead wires with tape.

2. External signal output

*To use external output, an external input/output adapter (PAC-YT41HAA; sold separately) is required.

Requires a separate external power source.

(1) External signal output (CN3)

Operation signal will be output when one or more air conditioning units are in operation, and error signal will be output when one or more units are in error.

The On-signal will be output even during an error.

(2) External output specifications

CN3	Lead wire	Signal
1	Brown	ON/OFF
2	Red	Error/Normal

CN3	Lead wire	Signal
3	Orange	Ground for all external outputs
4	Yellow	Not used

(3) Sample circuit recommended

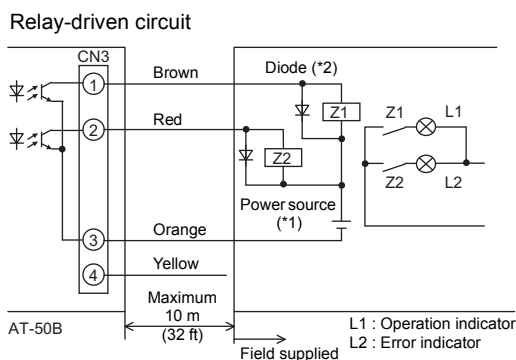

Use relays that meet the following specifications for relays indicated as Z1 and Z2 in the figure.

Operating coil

Rated voltage: 12 VDC or 24 VDC

Power consumption: 0.9 W or below

(*1) Select a power supply suitable for the relays used. (12 VDC or 24 VDC)

(*2) Use a diode at each end of the relay coil.

- Each element will turn on when an error occurs during operation.
- The maximum length of extension cable is 10 m (32 ft). (Use a cable of 0.3 mm² (22AWG) or thicker.)
- Insulate the area with vinyl tape where the controller cable and the extension cable are connected.
- Relays, lamps, diode, extension cables are field-supplied.

Note

- To connect cables from an external input/output adapter to connectors CN2 and CN3 on the controller, cut out the appropriate knockout holes on the controller with nippers. After connecting the cables to the connectors, hold the cables in place with a piece of tape included with the external input/output adapter (PAC-YT41HAA).
- Use caution not to damage the circuit board with the nippers or other tools when cutting out knockout holes.

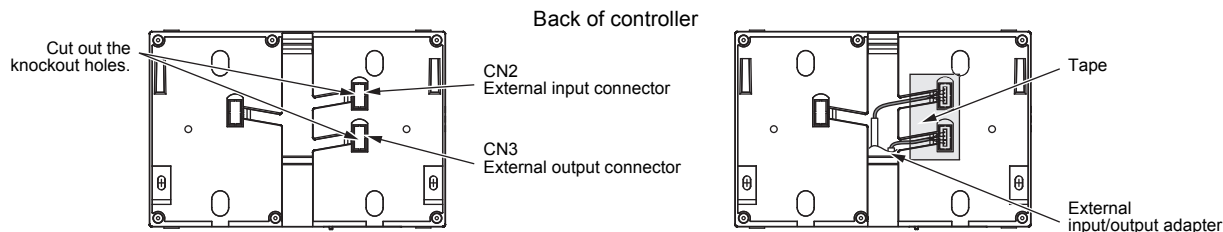

1-8. Using an SD memory card

The AT-50B has a slot for an SD memory card at the bottom that can be used to update software.

Refer to the Installation Manual for the detailed information about updates.

*Only the 1GB and 2GB SD memory cards by SanDisk are supported. "SD Logo is a trademark of SD-3C, LLC."

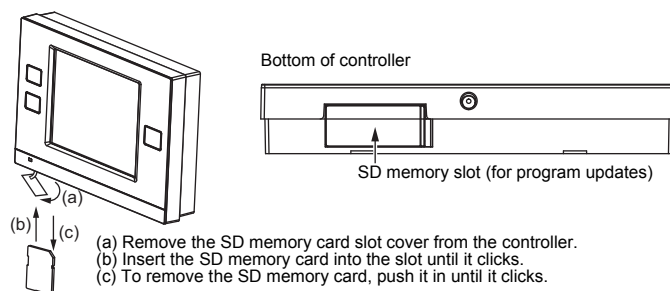

1-9. Optional Parts

Parts	Model	Usage	Note
External input/output adapter	PAC-YT41HAA	Enables the use of external input/output function	Required to use the external input/output function 5-wire cable (input) , 4-wire cable (output)

1-10. Note

■ A protective film is placed on the display.

Remove the protective film off the display before use.

Chapter 2. Initial Setting

This chapter contains information about the settings to be made at the time of installation. Please read the instructions carefully and make the settings accordingly. Refer to Chapter 1. "Installation" for how to install the AT-50B Advanced Touch Controller, and refer to the air conditioning unit installation manuals for how to connect the controller cable to the air conditioning units, or how to install the air conditioning units. Please remember to give all manuals to the end users after installation is complete.

2-1. AT-50B Advanced Touch Controller



List of functions available under the "Service menu"

Screen	Setting	Function	Page
Basic settings	M-NET address	Sets the M-NET address for the AT-50B.	12
	Main system controller/ sub system controller (*1)	Set the system controller as the main or sub.	12
	Operation prohibit setting (Used/Not used)	Use to select the type of controller from which to prohibit the access of the local remote controllers (from other system controllers).	12
	Remote controller access	Selects the type of controllers to prohibit access* from (remote controllers only or both remote controllers and sub-system controllers). * Access to ON/OFF, Mode, Set Temp, Filter Reset, Air Direction, Fan Speed, Timer, and Check Water sign (Air To Water (PWFY)).	12
	External input mode	Selects the external input mode.	12
	Filter sign	Displays or suppresses the Filter sign on the HOME screen.	12
	Dry mode	Includes or excludes Dry mode as an option for the operation mode.	12
	Operation mode control (*2)	Selects the function "System-Changeover" or "Operation Mode Selection Limit".	13
	Time notification	Sends or does not send the clock synchronization signal once a day to the controllers and units.	13
Group settings	Groups (*3)	Makes the group settings for the indoor units, Air To Water (PWFY), LOSSNAY units, DIDO controllers (PAC-YG66DCA), remote controllers, and sub-system controllers.	13
	Interlocked operation	Enters the interlock settings between indoor and LOSSNAY units.	14
	Batch deletion (*2)	Deletes all group and interlock settings collectively.	14
Maintenance	System view	Displays the information about the indoor units connected to each outdoor unit.	15
	Malfunction log	Stores the latest errors. (up to 50)	15
	Checking the Gas Amount (*2)	Use to check for refrigerant leak from the outdoor unit.	16
	Software update	Updates software.	16
Test run	Test run	Runs a test on the connected air conditioning units.	15

(*1) Refer to section 1-5 "Note."

(*2) Available only when AT-50B is set as a main controller.

(*3) AHC (Advanced HVAC CONTROLLER) cannot be controlled from AT-50B.

2-2. AT-50B Screen Configurations

(1) Screen sequence and Service menu configuration.

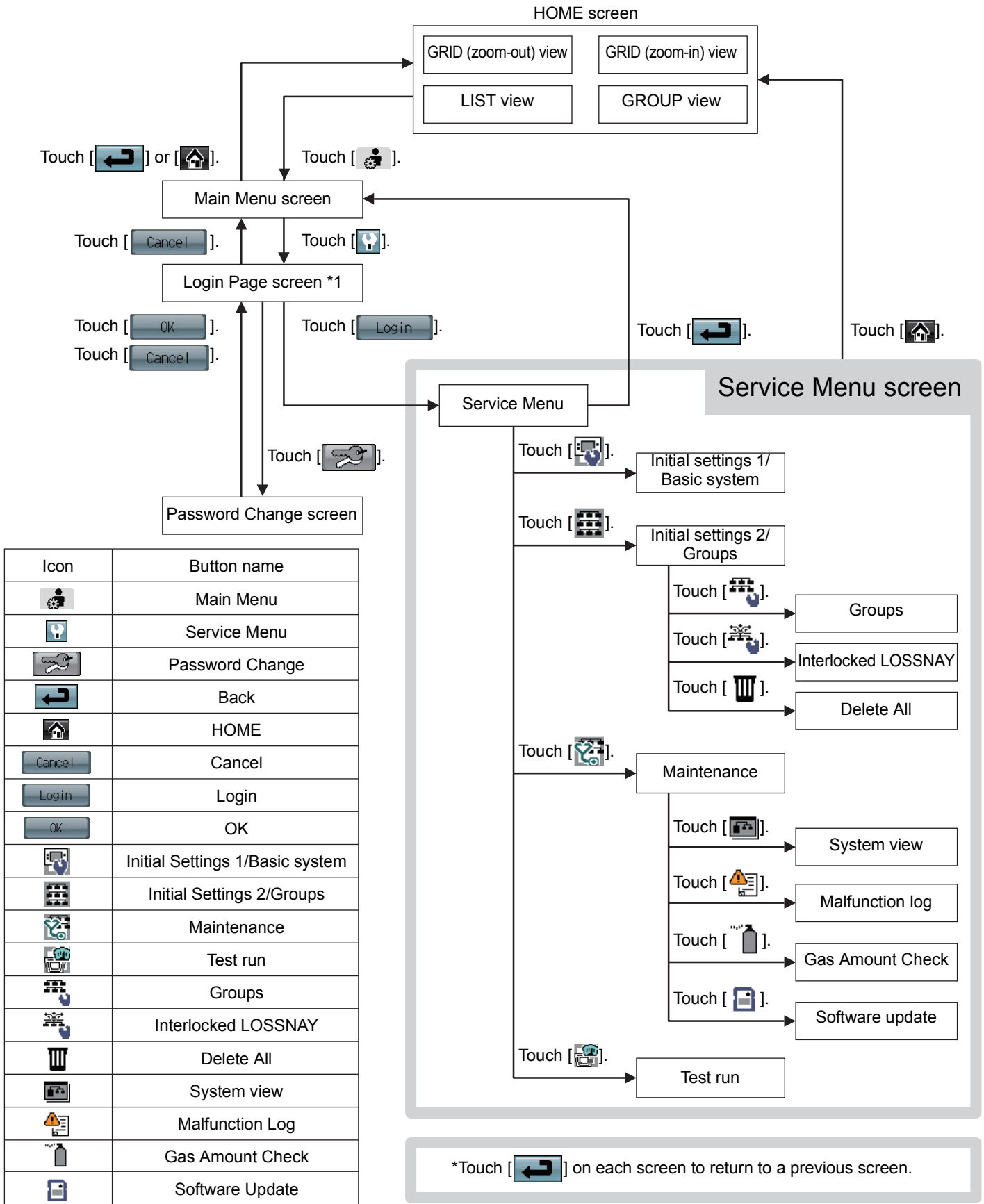

*1 A password is required to access the Service menu.

- The initial Service password is "9999." Change the password as necessary to prevent unauthorized access.
- Make sure the password is available to the maintenance and other necessary personnel.
- The password can be set to an arbitrary number between four and eight digits.
- If you forget your password, log in with the master password.
Master password: 105638
- The same master password is used to log in to specific screens under the "Main Menu" and the "Service Menu."

2-3. Initial Settings

(1) Initial startup settings:

Before turning on the controller, first make sure that the controller, indoor units, and outdoor units have been installed properly according to the instructions detailed in the respective manuals.

Turn on the controller and the units.

- This manual is intended for the first startup after the unit has been shipped from the factory. If the setting has been changed even once, the popup window or setting screens explained below may not appear. In this case, see section “Usage-Main Menu Setting” in the Instruction Book.
- AT-50B can be used as a Main controller or a Sub controller. At the time of factory shipment, AT-50B is set as a Main controller. The Main/Sub setting can be changed on the Initial Settings 1/ Basic System screen from the Service menu. (Refer to section 2-3(2)-1 for details.)
- Change the Main/Sub setting before making other initial settings, otherwise some saved information will be lost upon restart after the setting is changed.



(a) The Language screen will appear.

- ① Select the display language.
- ② Touch the button to select the language of your choice.
- ③ Touch the OK button.



(b) The Date and Time screen will appear.

- ① Set the current date on the Date tab, and set the current time on the Time tab, using the ▼ and ▲ buttons to change the values.
- ② Click on the checkbox next to the date/time format of your choice.
- ③ Touch the Save button to save the settings.

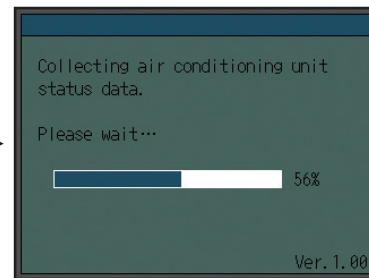

<When a popup message “Make a setting from Initial Settings 1.” appears>

- Press the OK button to close the popup window and display the Service Menu screen.
- Touch the Initial Settings 1/ Basic System button to make a setting. (Refer to section 2-3(2)-1 for details about Basic controller settings.)
Save the settings, and go back to the Service Menu.
- Touch the Initial Settings 2/ Groups button to make a setting. (Refer to section 2-3(2)-2 for details about Group settings, 2-3(2)-3 for details about Interlocked settings.)
Save the settings, and go back to the Service Menu.
- Touch HOME button [] to bring up a popup confirmation screen.
Press the OK button to begin the communication.
- The message (shown above) will appear on the screen, displaying the initialization progress. When initialization is complete, the screen will automatically return to the HOME screen.
(Initialization will take up to five minutes.)
* To change settings later, perform a test run, or verify the maintenance information.
 - ① Touch MAIN MENU button [] on the HOME screen.
 - ② Touch SERVICE MENU button [] on the Main Menu screen.
 - ③ Enter the password to log on to the Service Menu screen. (Refer to section 2-3, 2-4, and 2-5.)



<When a popup message “Make a group setting using the Main controller. When the group setting has been made, reset the power to the Main controller.” appears>

- While the popup message is displayed, the unit communicates with the main controller. The popup window will close when the communication is completed.
* To change the settings, press the Cancel button while the popup window is displayed. The Initial Settings 1/ Basic System screen will appear. If Basic controller settings are not made yet, change the settings.
- The message (shown above) will appear on the screen, displaying the initialization progress. When initialization is complete, the screen will automatically return to the HOME screen.
(Initialization will take up to ten minutes.)
* The group name needs to be set on the Sub controller after normal startup, as it cannot be sent from the Main controller. Refer to the Instruction Book for details.

(2) Other Initial Settings

(2)-1. Basic controller setting

Touch Initial Settings 1/Basic System button [] on the Service menu screen to access the Initial Settings 1/Basic System screen.

Touch Page turn button [] [] to turn the pages, and follow the directions below to make the settings.

M-NET Address

- 1) Touch the M-NET Address button (labeled ① in the figure), and set the AT-50B Controller address on the screen that pops up.
 - The address can be set to 000 or to a value between 201 and 250 (the factory setting is 201).

Main or sub controller setting (when connecting both main and sub controllers)

- 1) Touch the button marked ② in the figure to set MAIN or SUB for the controller.
 - The factory setting is MAIN.

Operation prohibit setting

- 1) Touch the button marked ③ in the figure to use or not use the Operation prohibit setting.
 - To prohibit the operation from the local remote controllers or the sub-system controllers, select "Enabled." If this setting is set to "Enabled," a button will appear in the place marked ④ in the figure.

Remote Controller Access

- 1) Touch the Remote Controller Access setting button (labeled ④ in the figure) to switch between "SC/RC" and "RC only."
 - Select "SC/RC" to prohibit access* from both the system controllers and remote controllers, and select "RC only" to prohibit access from only the remote controllers.
 - * Access to ON/OFF, Mode, Set Temp, Filter Reset, Air Direction, Fan Speed, Timer, and Check Water sign.

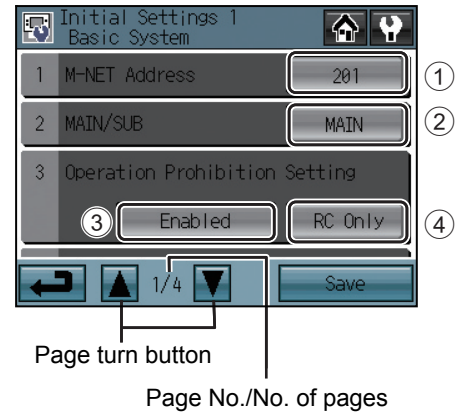

External Input Mode

- 1) Press the External Input setting button (labeled ① in the figure) to select between "Not used," "Emergency Stop (Level signal)," "ON/OFF (Level signal)," and "ON/OFF/Prohibit/Permit (Pulse signal)."
 - * Refer to the Installation Manual for detailed information on how to connect the AT-50B to external devices.



Filter Sign Display

- 1) Press the Filter Sign Display button (labeled ① in the figure) to switch between ON and OFF.
 - Setting this item to OFF will remove the Filter Sign from the HOME screen display. This item can be set to OFF if there is no need for the sign to appear on the HOME screen; for example, in cases where filters are regularly changed regardless of the filter sign status.

Dry Mode

- 1) Press the Dry Mode Setting button (labeled ② in the figure) to switch between "Used" and "Not Used."
 - If this item is set to "Not Used," the Dry mode will be unavailable for selection.



Operation Mode Control (Available only when AT-50B is set as a main controller)

- 1) Touch the button marked ① in the figure to switch the following functions.
 - System-Changeover: Based on the room temperature and the preset temperature, the operation mode (cooling or heating) is automatically switched for the whole system.
 - Operation Mode Selection Limit: The specific operation mode's changeover is restricted for this remote controller and other local remote controllers of all groups.

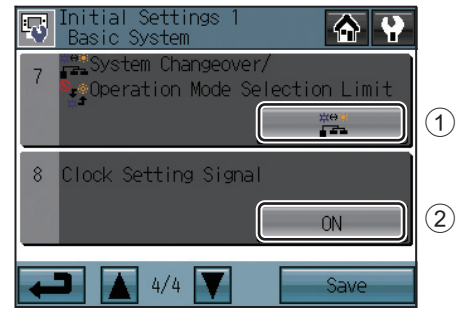

Clock Setting Signal

- 1) Touch the Clock Setting Signal button (labeled ② in the figure) to send or not send the clock synchronization signals to other controllers and units.
 - If the Clock Setting Signal is set to “ON,” signals to synchronize the current time will periodically be sent to all system controllers and remote controllers that have a built-in clock function.
 - * MA remote controllers that are connected to Mr. SLIM® units will not synchronize the clock and date. Also, the clock and date synchronization may not operate on certain CITY MULTI units.

Saving the Settings

- 1) Touch the Save button to save the settings.

(2)-2. Group Settings

This setting can be made only when AT-50B is set as a main controller. If AT-50B is set as a sub controller, the setting can be monitored only.

Enter the group settings on the Groups screen (air conditioning units, general equipment (and their respective group names) that are connected to AT-50B). Touch Initial Settings 2/Groups button [] on the Service Menu screen, and then touch Groups button [] on the Initial Settings 2/Groups screen to access the Groups screen. The DIDO controller (PAC-YG66DCA) by Mitsubishi Electric is required to control general equipments.

- * General equipments: Refer to the types of equipments such as fans and lighting fixtures that are connected to the contacts. Each contact of general equipment counts as one unit, and up to 50 units (indoor units and LOSSNAY units combined) or their equivalent can be connected to each AT-50B.

(Sample system)

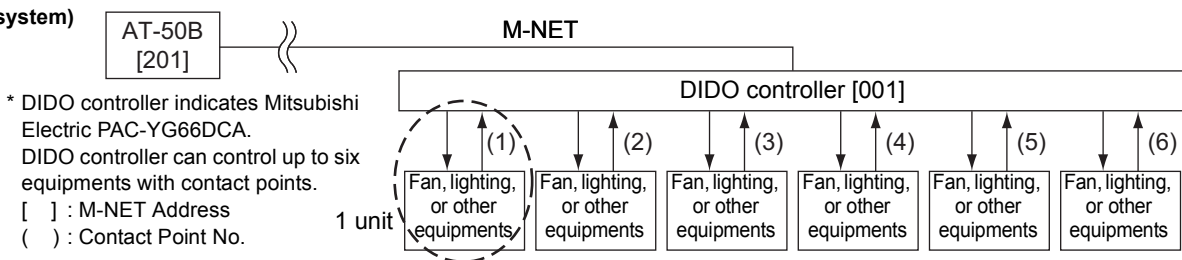

Up to 16 units can be assigned to each group. Indoor units, LOSSNAY units, and general equipment cannot be combined in one group. General equipment groups cannot include remote controller or system controllers. Touch Page turn button [] [] to turn the pages, and follow the directions below to make the settings for each group.

Group Name

- 1) Touch the Group Name Input button (labeled ① in the figure), and enter the group name in the screen. (up to 16 characters maximum)
- 2) The name of a group can be copied and pasted into another group name field. Access the name of the group to be copied using the arrow buttons, and touch the Copy button []. Access the page to paste the copied group name onto, and touch the Paste button [].



Group setting screen

Group Settings for air conditioning units and Air To Water (PWFY) units

- 1) Touch the Model selection button (labeled ② in the figure) to access the Model Selection screen. Touch the Model selection button (labeled ⑥ in the figure) so that “Air conditioners”, “LOSSNAY”, or “Air To Water” appears on the screen.
- 2) Touch the Unit selection button (labeled ③ in the figure). On the popup window that appears, check the address of the units to be included.
- 3) To assign a remote controller to a group, check the address of controller on the popup window that appears when the Remote controller selection button (labeled ④ in the figure) is touched.
 - * Up to two remote controllers can be assigned to each group. (Group settings do not need to be made for the MA remote controllers.)
 - * Do not assign a remote controller that does not support Air To Water (PWFY) to Air To Water (PWFY) group, which may result in unit malfunction.
- 4) To assign a system controller to a group, check the address of the controller on the popup window that appears when the System controller selection button (labeled ⑤ in the figure) is touched.
 - * Up to four remote and system controllers combined can be assigned to each group.
 - * Do not assign a system controller that does not support Air To Water (PWFY) to Air To Water (PWFY) group, which may result in unit malfunction.
- 5) After all the settings have been made, touch the Save button.



Model selection screen

Group Settings for General Equipment

- 1) Touch the Model selection button (labeled ② in the figure) to access the Model selection screen.
Touch the Model selection button (labeled ④ in the figure) a few times so that "General Equipment" appears.
- 2) To change the icons, touch the Icon Selection button (labeled ⑦ in the figure), and select the desired one.
- 3) Touch the General equipment operation setting button (labeled ⑤ in the figure) to allow or disallow (monitor only) the user to start/stop the connected equipment via the AT-50B.

In batch and on individual group	Units can be turned on or off either collectively or by group from the AT-50B.
On individual group	Only certain groups of units can be turned on or off from the AT-50B.
No operations (Monitor only)	Units cannot be turned on or off from the AT-50B.

- 4) Touch the General equipment display setting button (labeled ⑥ in the figure) and choose between the following ON/OFF status display options on the HOME screen: "Output status to the general equipment" or "Input status from the general equipment."
- 5) Touch the Unit selection button (labeled ③ in the figure). On the popup window that appears, check the address and the contact number of the DIDO controller (PAC-YG66DCA) to which the general equipment is connected.
- 6) After all the settings have been made, touch the Save button on the Groups screen.



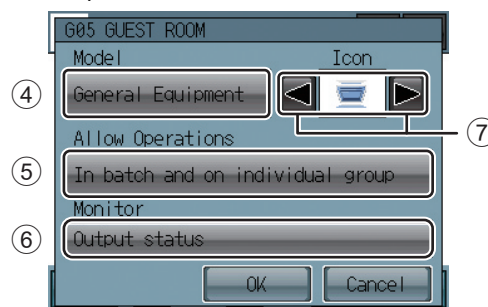

Group setting screen



Model selection screen

(2)-3. Interlocked settings between indoor units and ventilation units (LOSSNAY and OA processing units)

To interlock the ON/OFF status of the ventilation units with the indoor units, make the settings through the "Interlocked LOSSNAY" screen.



- * Touch the Initial Settings 2/Groups button [] on the Service Menu, and then touch the Interlocked LOSSNAY button [] on the Initial Settings 2/Groups screen to access the Interlocked LOSSNAY screen.



- 1) Touch the LOSSNAY button (labeled ① in the figure). On the popup window that appears, check the address of the ventilation units to be interlocked with the operation of the indoor units.
- 2) Touch the Interlocked indoor unit button (labeled ② in the figure). On the popup window that appears, check the address of the indoor units to be interlocked with the ventilation units.
* Up to 16 indoor units can be assigned to each ventilation unit.
- 3) After all interlocked operation settings have been made, touch the Save button.

(2)-4. Batch deletion (Available only when AT-50B is set as a main controller)

To delete all group and interlocked operation settings collectively, follow the procedure below.

- 1) Touch the Initial Settings 2/Groups button [] on the Service Menu screen, then touch the Delete All button [] on the Initial Settings 2/Groups screen. A popup message "Do you want to delete all group settings and interlocked LOSSNAY settings?" will appear.
- 2) Touch the OK button to delete group and interlock.

2-4. Test run

To run a test, follow the procedure below.

(1) Touch the Test Run button on the Service Menu screen to access the Test Run screen.

(2) Touch the OFF(ON) button (labeled ① in the figure) to run a test on the group.

Test Run screen



①	OFF(ON)/Test Run	Touch the OFF(ON) button to start a test run. Touch the Test Run button to stop the test run. (These buttons are active only for the units that support the test run function.) * If  is displayed at the left top of the button, it indicates that the group is Air To Water (PWFY) group.
②	Operation mode	Touch this button to switch the operation mode.
③	Pipe temperature*1	The pipe temperature of the unit with the lowest address in a given group will appear.
④	Advanced settings	Touch this button for advanced settings.

*1 The water temperature will appear if the group is Air To Water (PWFY) group. The water temperature to be displayed depends on which temperature sensor is selected on Air To Water (PWFY) side.

Test Run Advanced setting screen



	Display	Function
A	Indoor temperature*2	Indoor air temperature will appear.
B	Unit address up/down arrows	Use the up/down arrows to select the unit whose pipe temperature you want to check.
C	Pipe temperature*1	The pipe temperature of the unit whose address is shown on the screen will appear.
D	Remaining time	The remaining time for the test run will appear.

*1 The water temperature will appear if the group is Air To Water (PWFY) group.

*2 Indoor temperature will not appear if the group is Air To Water (PWFY) group.

(3) During the test run, verify that air conditioned air is blowing out of the supply air outlet.

(4) After checking for normal operation of each unit, stop the units through AT-50B or the local remote controllers.

* Refer to the unit installation manual for the detailed information about test run.

2-5. Maintenance

Touch the Maintenance button [] on the Service Menu screen to access the Maintenance screen.

(1) To view the System information

Touch [System View] button on the Maintenance screen to view a list of equipments connected to the same refrigerant system.

* Only the ones whose startup procedures have been successfully completed will appear in the list.

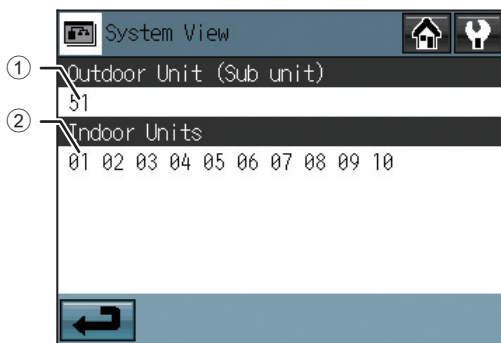

Display content		
①	Outdoor unit address	The addresses of the outdoor units that are connected to AT-50B will appear. (The number in the parentheses indicates the address of the Sub unit.)
②	Indoor unit address	The addresses of the indoor units that are connected to given outdoor units will appear.

(2) To view the Malfunction Log

Touch the Malfunction Log button on the Maintenance screen to view. The latest 50 malfunctions will appear three at a time.

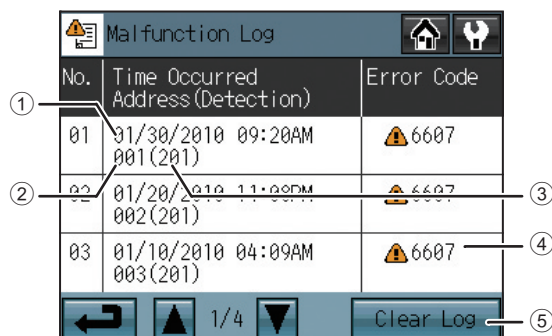

Display content		
①	Occurrence date	The date on which the error occurred.
②	Error source unit address	The address of the unit with the error.
③	Error detection unit address	The address of the unit that detected the error.
④	Error code	The error code that corresponds to the error.
⑤	Clear Log button	Use this button to clear all records on the Malfunction Log.

* Refer to the Instruction Book on how to make the settings not mentioned in this manual (e.g., schedule settings and button lock settings).

- (3) Checking the Gas Refrigerant Amount (Use this option to check for refrigerant leak from the outdoor unit. This option is available only when AT-50B is set as a main controller.)

Touch the Gas Amount Check button on the Maintenance Menu.

A screen will appear that allows the user to check the gas refrigerant amount.

* Those outdoor units that do not support the gas refrigerant amount checking function will not appear on this screen.

* This check will be performed in a specific operation mode and takes from 30 minutes to 1 hour.

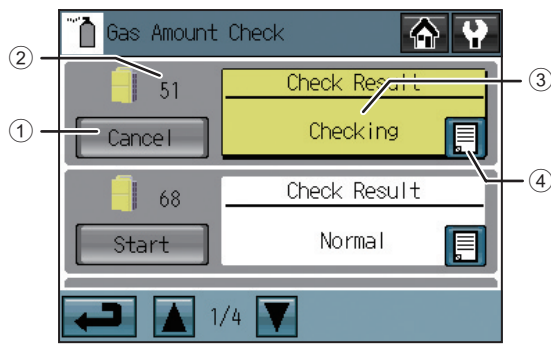

Display content		
①	[Check Start] button	Touch to start checking the gas refrigerant amount.
②	Outdoor unit address	Outdoor unit address is displayed here.
③	Check results	Check results are displayed here.
④	Log	Touch to display the log (up to 10 results) here.

1. Start the gas refrigerant amount check.

Click the [Check start] button to check an individual unit. Click the [Check cancel] button to stop checking.

* When the [Check Start] button is clicked, it will change to the [Check cancel] button.

2. Check the results.

This check will be completed in 30 minutes to 1 hour, and check results will be displayed upon completion.

When the amount of refrigerant charge is normal, [Normal] will appear on the screen, and if the outdoor units are low on refrigerant due to leaks, [Low] will appear.

* It is not necessary to keep this page open until checking is completed. Even if the screen is closed, the check results and the log will be displayed next time this page is opened.

To Update The Software (as necessary)

- 1) Touch the Software Update button [] on the Maintenance Menu.

- 2) Following the instructions on the screen, insert the SD memory card with the update program into the SD slot, and then touch the OK button.

* If a message [Unable to read the SD card] appears, check to make sure that the SD memory card is properly inserted.

* If a message [Update file was not found] appears, check to make sure the SD memory card contains the updated program.

- 3) Following the instructions on the screen, remove the cover on the controller by unscrewing the screws at the bottom, turn DIP switch 4 to ON, and then touch the OK button.

* If the message [The DIP switch 4 is set to OFF.] appears, check to make sure that the DIP switch 4 is turned to ON.

The DIP switch is located at the left bottom of the controller under the cover.

- 4) Touch the OK button on the confirmation screen.

- 5) Touch the OK button on the popup message to begin the update process.

Note: Software updates will take approximately five minutes. Do not remove the SD card or switch off the power while an update is in progress. If the power is turned off during the update process, the program may be lost and the system will not be able to start.

- 6) The lit LEDs on the three buttons (F1, F2, and Collective ON/OFF) will indicate a successful completion of the update. While update is in progress, the LEDs on the F1 and F2 buttons will alternately blink.

* Consult your dealer if the update is not completed in 10 minutes.

- 7) After the update has been completed, turn the DIP switch 4 to OFF to restart the AT-50B. When the initialization screen appears, check that the software version that appears at the bottom right corner is correct. If it shows the old version, the update failed. Try updating the software again.

* Only 1 GB and 2 GB SD memory cards by SanDisk are supported.

* SanDisk is a registered trademark of SanDisk Corporation in the United States and other countries.



“SD Logo is a trademark of SD-3C, LLC.”

The product is designed and intended for use in residential, commercial, and light-industrial environment.

This product at hand is based on the following EU regulations.

- Electromagnetic Compatibility Directive 2004/108/EC

- Restriction of Hazardous Substances 2011/65/EU

MITSUBISHI ELECTRIC CORPORATION

HEAD OFFICE: TOKYO BLDG., 2-7-3, MARUNOUCHI, CHIYODA-KU, TOKYO 100-8310, JAPAN

Authorized representative in EU: MITSUBISHI ELECTRIC EUROPE B.V.

HARMAN HOUSE, 1 GEORGE STREET, UXBRIDGE, MIDDLESEX UB8 1QQ, U.K.