

Air-Conditioners

PUMY-P100, P125, P140YHMB

INSTALLATION MANUAL

For safe and correct use, read this manual and the indoor unit installation manual thoroughly before installing the air-conditioner unit.

FOR INSTALLER**English**

INSTALLATIONSHANDBUCH

Aus Sicherheitsgründen und zur richtigen Verwendung vor der Installation die vorliegende Bedienungsanleitung und die Installationsanleitung der Innenanlage gründlich durchlesen die Klimaanlage.

FÜR INSTALLATEURE**Deutsch**

MANUEL D'INSTALLATION

Avant d'installer le climatiseur, lire attentivement ce manuel, ainsi que le manuel d'installation de l'appareil intérieur pour une utilisation sûre et correcte.

POUR L'INSTALLATEUR**Français**

INSTALLATIEHANDLEIDING

Lees deze handleiding en de installatiehandleiding van het binnenapparaat zorgvuldig door voordat u met het installeren van de airconditioner begint.

VOOR DE INSTALLATEUR**Nederlands**

MANUAL DE INSTALACIÓN

Para un uso correcto y seguro, lea detalladamente este manual y el manual de instalación de la unidad interior antes de instalar la unidad de aire acondicionado.

PARA EL INSTALADOR**Español**

MANUALE DI INSTALLAZIONE

Per un uso sicuro e corretto, leggere attentamente il presente manuale ed il manuale d'installazione dell'unità interna prima di installare il condizionatore d'aria.

PER L'INSTALLATORE**Italiano**

ΕΓΧΕΙΡΙΔΙΟ ΟΔΗΓΙΩΝ ΕΓΚΑΤΑΣΤΑΣΗΣ

ΓΙΑ ΑΥΤΟΝ ΠΟΥ ΚΑΝΕΙ ΤΗΝ ΕΓΚΑΤΑΣΤΑΣΗ

Για σωστή και ασφαλή χρήση, διαβάστε προσεκτικά αυτό το εγχειρίδιο καθώς και το εγχειρίδιο εγκατάστασης της εσωτερικής μονάδας, προτού εγκαταστήσετε τη μονάδα του κλιματιστικού.

Ελληνικά

MANUAL DE INSTALAÇÃO

Para uma utilização segura e correcta, leia atentamente este manual e o manual de instalação da unidade interior antes de instalar o aparelho de ar condicionado.

PARA O INSTALADOR**Português**

INSTALLATIONSMANUAL

Læs af sikkerhedshensyn denne manual samt manualen til installation af indendørsenheden grundigt, før du installerer klimaanlægget.

TIL INSTALLATØREN**Dansk**

INSTALLATIONSMANUAL

Läs bruksanvisningen och inomhusenhetens installationshandbok noga innan luftkonditioneringen installeras så att den används på ett säkert och korrekt sätt.

FÖR INSTALLATÖREN**Svenska**

MONTAJ ELKİTABI

Emniyetli ve doğru kullanım için, klima cihazını monte etmeden önce bu kılavuzu ve iç ünite montaj kılavuzunu tamamiyle okuyun.

MONTÖR İÇİN**Türkçe**

РУКОВОДСТВО ПО УСТАНОВКЕ

Для обеспечения безопасной и надлежащей эксплуатации внимательно прочтите данное руководство и руководство по установке внутреннего прибора перед установкой кондиционера.

ДЛЯ УСТАНОВИТЕЛЯ**Русский**

安装说明书

安装空调器之前，请先通读本说明书和室内机组安装说明书，以便安全正确地使用本机。

安装人员适用**中文**

Contents

1. Safety precautions	2	5. Drainage piping work	9
2. Installation location	4	6. Electrical work	9
3. Installing the outdoor unit	6	7. Test run	12
4. Installing the refrigerant piping	6		



Note: This symbol mark is for EU countries only.

This symbol mark is according to the directive 2002/96/EC Article 10 Information for users and Annex IV.

Your MITSUBISHI ELECTRIC product is designed and manufactured with high quality materials and components which can be recycled and reused. This symbol means that electrical and electronic equipment, at their end-of-life, should be disposed of separately from your household waste.

Please, dispose of this equipment at your local community waste collection/recycling centre.

In the European Union there are separate collection systems for used electrical and electronic product.

Please, help us to conserve the environment we live in!

⚠ Caution:

- Do not vent R410A into the Atmosphere:
- R410A is a Fluorinated Greenhouse gas, covered by the Kyoto Protocol, with a Global Warming Potential (GWP)=1975.

Confirmation of parts attached

In addition to this manual, the following parts are supplied with the outdoor unit. They are used for grounding the S terminals of transmission terminal blocks TB3, TB7. For details refer to "6. Electrical work".

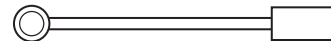

Grounding lead wire (x 2)

1. Safety precautions

- ▶ Before installing the unit, make sure you read all the "Safety precautions".
- ▶ Please report to or take consent by the supply authority before connection to the system.

⚠ Warning:

Describes precautions that must be observed to prevent danger of injury or death to the user.

⚠ Caution:

Describes precautions that must be observed to prevent damage to the unit.

⚠ Warning:

- The unit must not be installed by the user. Ask a dealer or an authorized technician to install the unit. If the unit is installed incorrectly, water leakage, electric shock, or fire may result.
- For installation work, follow the instructions in the Installation Manual and use tools and pipe components specifically made for use with R410A refrigerant. The R410A refrigerant in the HFC system is pressurized 1.6 times the pressure of usual refrigerants. If pipe components not designed for R410A refrigerant are used and the unit is not installed correctly, the pipes may burst and cause damage or injuries. In addition, water leakage, electric shock, or fire may result.
- The unit must be installed according to the instructions in order to minimize the risk of damage from earthquakes, typhoons, or strong winds. An incorrectly installed unit may fall down and cause damage or injuries.
- The unit must be securely installed on a structure that can sustain its weight. If the unit is mounted on an unstable structure, it may fall down and cause damage or injuries.
- If the air conditioner is installed in a small room, measures must be taken to prevent the refrigerant concentration in the room from exceeding the safety limit in the event of refrigerant leakage. Consult a dealer regarding the appropriate measures to prevent the allowable concentration from being exceeded. Should the refrigerant leak and cause the concentration limit to be exceeded, hazards due to lack of oxygen in the room may result.
- Ventilate the room if refrigerant leaks during operation. If refrigerant comes into contact with a flame, poisonous gases will be released.
- All electric work must be performed by a qualified technician according to local regulations and the instructions given in this manual. The units must be powered by dedicated power lines and the correct voltage and circuit breakers must be used. Power lines with insufficient capacity or incorrect electrical work may result in electric shock or fire.

After installation work has been completed, explain the "Safety Precautions," use, and maintenance of the unit to the customer according to the information in the Operation Manual and perform the test run to ensure normal operation. Both the Installation Manual and Operation Manual must be given to the user for keeping. These manuals must be passed on to subsequent users.

⚡ : Indicates a part which must be grounded.

⚠ Warning:

Carefully read the labels affixed to the main unit.

- Use C1220 copper phosphorus, for copper and copper alloy seamless pipes, to connect the refrigerant pipes. If the pipes are not connected correctly, the unit will not be properly grounded and electric shock may result.
- Use only specified cables for wiring. The connections must be made securely without tension on the terminals. If the cables are connected or installed incorrectly, overheating or fire may result.
- The terminal block cover panel of the outdoor unit must be firmly attached. If the cover panel is mounted incorrectly and dust and moisture enter the unit, electric shock or fire may result.
- When installing or moving the air conditioner, use only the specified refrigerant (R410A) to charge the refrigerant lines. Do not mix it with any other refrigerant and do not allow air to remain in the lines. Air enclosed in the lines can cause pressure peaks resulting in a rupture and other hazards.
- Use only accessories authorized by Mitsubishi Electric and ask a dealer or an authorized technician to install them. If accessories are incorrectly installed, water leakage, electric shock, or fire may result.
- Do not alter the unit. Consult a dealer for repairs. If alterations or repairs are not performed correctly, water leakage, electric shock, or fire may result.
- The user should never attempt to repair the unit or transfer it to another location. If the unit is installed incorrectly, water leakage, electric shock, or fire may result. If the air conditioner must be repaired or moved, ask a dealer or an authorized technician.
- After installation has been completed, check for refrigerant leaks. If refrigerant leaks into the room and comes into contact with the flame of a heater or portable cooking range, poisonous gases will be released.

1. Safety precautions

1.1. Before installation

⚠ Caution:

- Do not use the unit in an unusual environment. If the air conditioner is installed in areas exposed to steam, volatile oil (including machine oil), or sulfuric gas, areas exposed to high salt content such as the seaside, or areas where the unit will be covered by snow, the performance can be significantly reduced and the internal parts can be damaged.
- Do not install the unit where combustible gases may leak, be produced, flow, or accumulate. If combustible gas accumulates around the unit, fire or explosion may result.
- The outdoor unit produces condensation during the heating operation. Make sure to provide drainage around the outdoor unit if such condensation is likely to cause damage.
- When installing the unit in a hospital or communications office, be prepared for noise and electronic interference. Inverters, home appliances, high-frequency medical equipment, and radio communications equipment can cause the air conditioner to malfunction or breakdown. The air conditioner may also affect medical equipment, disturbing medical care, and communications equipment, harming the screen display quality.

1.2. Before installation (relocation)

⚠ Caution:

- Be extremely careful when transporting the units. Two or more persons are needed to handle the unit, as it weighs 20 kg or more. Do not grasp the packaging bands. Wear protective gloves to remove the unit from the packaging and to move it, as you can injure your hands on the fins or other parts.
- Be sure to safely dispose of the packaging materials. Packaging materials, such as nails and other metal or wooden parts may cause stabs or other injuries.
- The base and attachments of the outdoor unit must be periodically checked for looseness, cracks or other damage. If such defects are left uncorrected, the unit may fall down and cause damage or injuries.
- Do not clean the air conditioner unit with water. Electric shock may result.
- Tighten all flare nuts to specification using a torque wrench. If tightened too much, the flare nut can break after an extended period and refrigerant can leak out.

1.3. Before electric work

⚠ Caution:

- Be sure to install circuit breakers. If not installed, electric shock may result.
- For the power lines, use standard cables of sufficient capacity. Otherwise, a short circuit, overheating, or fire may result.
- When installing the power lines, do not apply tension to the cables. If the connections are loosened, the cables can snap or break and overheating or fire may result.
- Be sure to ground the unit. Do not connect the ground wire to gas or water pipes, lighting rods, or telephone grounding lines. If the unit is not properly grounded, electric shock may result.
- Use circuit breakers (ground fault interrupter, isolating switch (+B fuse), and molded case circuit breaker) with the specified capacity. If the circuit breaker capacity is larger than the specified capacity, breakdown or fire may result.

1.4. Before starting the test run

⚠ Caution:

- Turn on the main power switch more than 12 hours before starting operation. Starting operation just after turning on the power switch can severely damage the internal parts. Keep the main power switch turned on during the operation season.
- Before starting operation, check that all panels, guards and other protective parts are correctly installed. Rotating, hot, or high voltage parts can cause injuries.
- Do not touch any switch with wet hands. Electric shock may result.
- Do not touch the refrigerant pipes with bare hands during operation. The refrigerant pipes are hot or cold depending on the condition of the flowing refrigerant. If you touch the pipes, burns or frostbite may result.
- After stopping operation, be sure to wait at least five minutes before turning off the main power switch. Otherwise, water leakage or breakdown may result.

1.5. Using R410A refrigerant air conditioners

⚠ Caution:

- Use C1220 copper phosphorus, for copper and copper alloy seamless pipes, to connect the refrigerant pipes. Make sure the insides of the pipes are clean and do not contain any harmful contaminants such as sulfuric compounds, oxidants, debris, or dust. Use pipes with the specified thickness. (Refer to page 6) Note the following if reusing existing pipes that carried R22 refrigerant.
 - Replace the existing flare nuts and flare the flared sections again.
 - Do not use thin pipes. (Refer to page 6)
- Store the pipes to be used during installation indoors and keep both ends of the pipes sealed until just before brazing. (Leave elbow joints, etc. in their packaging.) If dust, debris, or moisture enters the refrigerant lines, oil deterioration or compressor breakdown may result.
- Use ester oil, ether oil, alkylbenzene oil (small amount) as the refrigeration oil applied to the flared sections. If mineral oil is mixed in the refrigeration oil, oil deterioration may result.
- Do not use refrigerant other than R410A refrigerant. If another refrigerant is used, the chlorine will cause the oil to deteriorate.
- Use the following tools specifically designed for use with R410A refrigerant. The following tools are necessary to use R410A refrigerant. Contact your nearest dealer for any questions.

Tools (for R410A)	
Gauge manifold	Flare tool
Charge hose	Size adjustment gauge
Gas leak detector	Vacuum pump adapter
Torque wrench	Electronic refrigerant charging scale

- Be sure to use the correct tools. If dust, debris, or moisture enters the refrigerant lines, refrigeration oil deterioration may result.
- Do not use a charging cylinder. If a charging cylinder is used, the composition of the refrigerant will change and the efficiency will be lowered.

2. Installation location

2.1. Refrigerant pipe

Refer to Fig. 4-1.

2.2. Choosing the outdoor unit installation location

- Avoid locations exposed to direct sunlight or other sources of heat.
- Select a location from which noise emitted by the unit will not inconvenience neighbors.
- Select a location permitting easy wiring and pipe access to the power source and indoor unit.
- Avoid locations where combustible gases may leak, be produced, flow, or accumulate.
- Note that water may drain from the unit during operation.
- Select a level location that can bear the weight and vibration of the unit.
- Avoid locations where the unit can be covered by snow. In areas where heavy snow fall is anticipated, special precautions such as raising the installation location or installing a hood on the air intake must be taken to prevent the snow from blocking the air intake or blowing directly against it. This can reduce the airflow and a malfunction may result.
- Avoid locations exposed to oil, steam, or sulfuric gas.
- Use the transportation handles of the outdoor unit to transport the unit. If the unit is carried from the bottom, hands or fingers may be pinched.

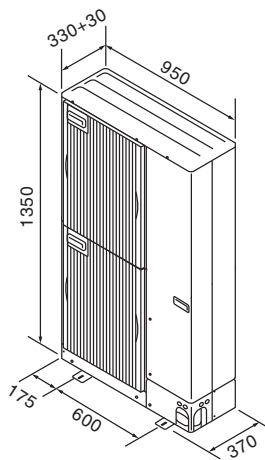

Fig. 2-1

(mm)

2.3. Outline dimensions (Outdoor unit) (Fig. 2-1)

Constraints on indoor unit installation

You should note that indoor units that can be connected to this outdoor unit are the following models.

- Indoor units with model numbers 15-140 (PUMY-P100:15-125) can be connected. Refer to the table 1 below for possible room, indoor unit combinations.

Verification

The rated capacity should be determined by observing the table below. The unit's quantities are limited as shown in the following table 2. For the next step, make sure that the total rated capacity selected will stay in a range of 50% - 130% of the outdoor unit capacity.

- PUMY-P100 5.6 - 14.6 kW
- PUMY-P125 7.1 - 18.2 kW
- PUMY-P140 8.0 - 20.2 kW

Table 1

Indoor unit type	15	20	25	32	40	50	63	71	80	100	125	140
Rated capacity (Cooling) (kW)	1.7	2.2	2.8	3.6	4.5	5.6	7.1	8.0	9.0	11.2	14.0	16.0

Table 2

Connectable indoor units quantities	
PUMY-P100	1-8
PUMY-P125	1-10
PUMY-P140	1-12*

Combinations in which the total capacity of indoor units exceeds the capacity of the outdoor unit will reduce the cooling capacity of each indoor unit below their rated cooling capacity. Thus, combine indoor units with an outdoor unit within the outdoor unit's capacity, if possible.

* Only when all the indoor units are 1.5 kW models, 12 indoor units can be connected to 1 outdoor unit.

2. Installation location

2.4. Ventilation and service space

2.4.1. When installing a single outdoor unit

Minimum dimensions are as follows, except for Max., meaning Maximum dimensions, indicated.

Refer to the figures for each case.

- ① Obstacles at rear only (Fig. 2-2)
- ② Obstacles at rear and above only (Fig. 2-3)
 - Do not install the optional air outlet guides for upward airflow.
- ③ Obstacles at rear and sides only (Fig. 2-4)
- ④ Obstacles at front only (Fig. 2-5)
 - When using an optional air outlet guide, the clearance is 500 mm or more.
- ⑤ Obstacles at front and rear only (Fig. 2-6)
 - When using an optional air outlet guide, the clearance is 500 mm or more.
- ⑥ Obstacles at rear, sides, and above only (Fig. 2-7)
 - Do not install the optional air outlet guides for upward airflow.

2.4.2. When installing multiple outdoor units

Leave 10 mm space or more between the units.

- ① Obstacles at rear only (Fig. 2-8)
- ② Obstacles at rear and above only (Fig. 2-9)
 - No more than three units must be installed side by side. In addition, leave space as shown.
 - Do not install the optional air outlet guides for upward airflow.
- ③ Obstacles at front only (Fig. 2-10)
 - When using an optional air outlet guide, the clearance is 1000 mm or more.
- ④ Obstacles at front and rear only (Fig. 2-11)
 - When using an optional air outlet guide, the clearance is 1000 mm or more.
- ⑤ Single parallel unit arrangement (Fig. 2-12)
 - When using an optional air outlet guide installed for upward airflow, the clearance is 1000 mm or more.
- ⑥ Multiple parallel unit arrangement (Fig. 2-13)
 - When using an optional air outlet guide installed for upward airflow, the clearance is 1500 mm or more.
- ⑦ Stacked unit arrangement (Fig. 2-14)
 - The units can be stacked up to two units high.
 - No more than two stacked units must be installed side by side. In addition, leave space as shown.

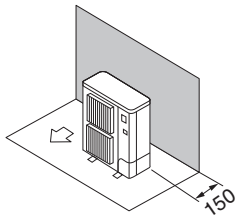

Fig. 2-2

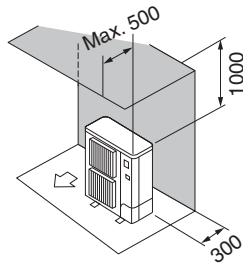

Fig. 2-3

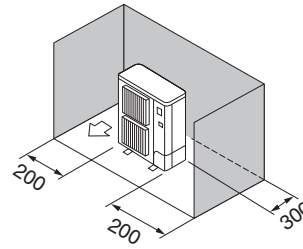

Fig. 2-4

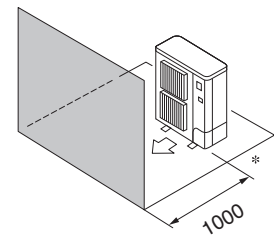

Fig. 2-5

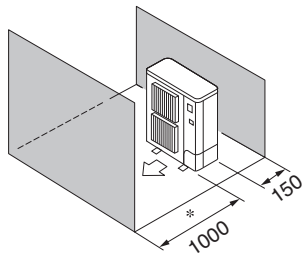

Fig. 2-6

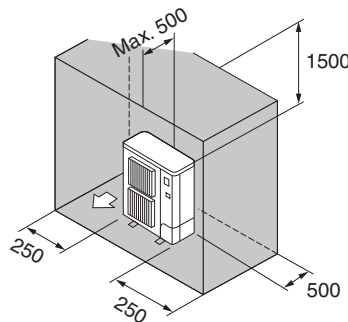

Fig. 2-7

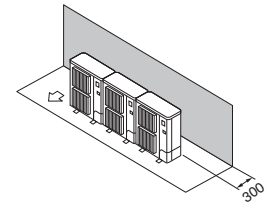

Fig. 2-8

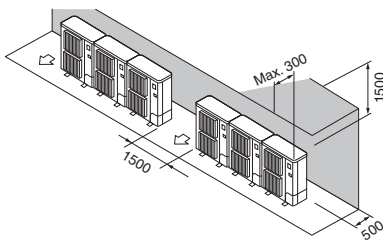

Fig. 2-9

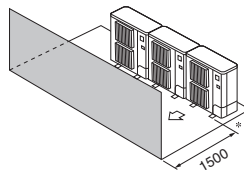

Fig. 2-10

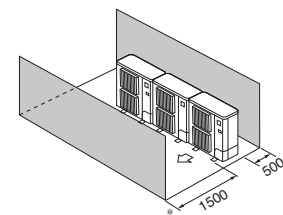

Fig. 2-11

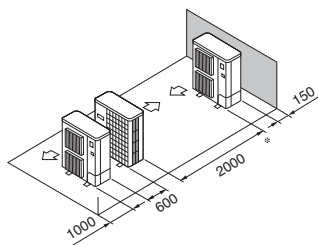

Fig. 2-12

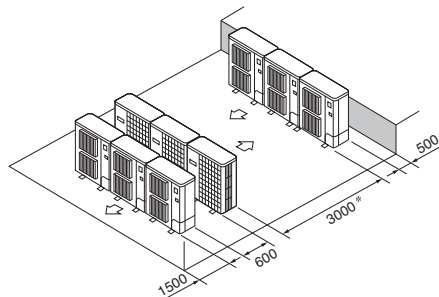

Fig. 2-13

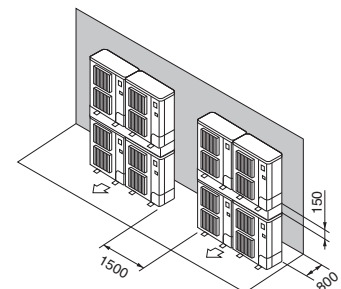

Fig. 2-14

2. Installation location

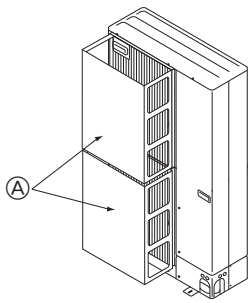

Fig. 2-15

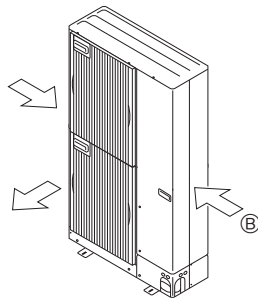

Fig. 2-16

2.4.3. Windy location installation

When installing the outdoor unit on a rooftop or other location unprotected from the wind, situate the air outlet of the unit so that it is not directly exposed to strong winds. Strong wind entering the air outlet may impede the normal airflow and a malfunction may result.

The following shows two examples of precautions against strong winds.

- ① Install an optional air guide if the unit is installed in a location where strong winds from a typhoon, etc. may directly enter the air outlet. (Fig. 2-15)
 - Ⓐ Air guide
- ② Position the unit so that the air outlet blows perpendicularly to the seasonal wind direction, if possible. (Fig. 2-16)
 - Ⓑ Wind direction

3. Installing the outdoor unit

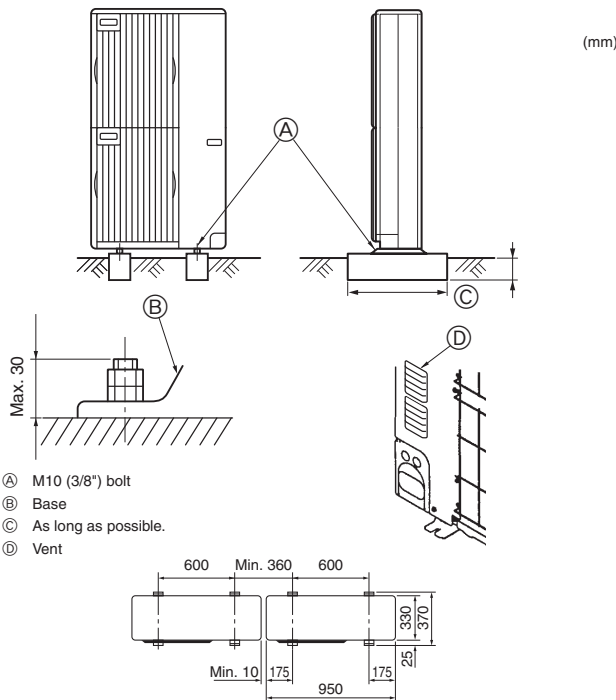

Fig. 3-1

- Be sure to install the unit in a sturdy, level surface to prevent rattling noises during operation. (Fig. 3-1)

<Foundation specifications>

Foundation bolt	M10 (3/8")
Thickness of concrete	120 mm
Length of bolt	70 mm
Weight-bearing capacity	320 kg

- Make sure that the length of the foundation bolt is within 30 mm of the bottom surface of the base.
 - Secure the base of the unit firmly with four-M10 foundation bolts in sturdy locations.
- Installing the outdoor unit**
- Do not block the vent. If the vent is blocked, operation will be hindered and breakdown may result.
 - In addition to the unit base, use the installation holes on the back of the unit to attach wires, etc., if necessary to install the unit. Use self-tapping screws (ø5 × 15 mm or less) and install on site.

⚠ Warning:

- **The unit must be securely installed on a structure that can sustain its weight. If the unit is mounted on an unstable structure, it may fall down and cause damage or injuries.**
- **The unit must be installed according to the instructions in order to minimize the risk of damage from earthquakes, typhoons, or strong winds. An incorrectly installed unit may fall down and cause damage or injuries.**

4. Installing the refrigerant piping

4.1. Precautions for devices that use R410A refrigerant

- Refer to page 3 for precautions not included below on using air conditioners with R410A refrigerant.
- Use ester oil, ether oil, alkylbenzene oil (small amount) as the refrigeration oil applied to the flared sections.
- Use C1220 copper phosphorus, for copper and copper alloy seamless pipes, to connect the refrigerant pipes. Use refrigerant pipes with the thicknesses specified in the table to the below. Make sure the insides of the pipes are clean and do not contain any harmful contaminants such as sulfuric compounds, oxidants, debris, or dust.

⚠ Warning:

When installing or moving the air conditioner, use only the specified refrigerant (R410A) to charge the refrigerant lines. Do not mix it with any other refrigerant and do not allow air to remain in the lines. Air enclosed in the lines can cause pressure peaks resulting in a rupture and other hazards.

Indoor unit type	15-50	63-140
Liquid pipe	ø6.35 thickness 0.8 mm	ø9.52 thickness 0.8 mm
Gas pipe	ø12.7 thickness 0.8 mm	ø15.88 thickness 1.0 mm

- Do not use pipes thinner than those specified above.

4. Installing the refrigerant piping

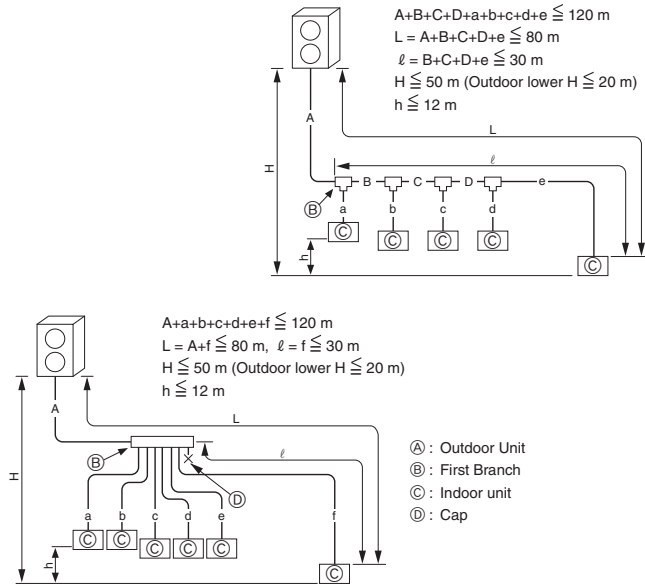
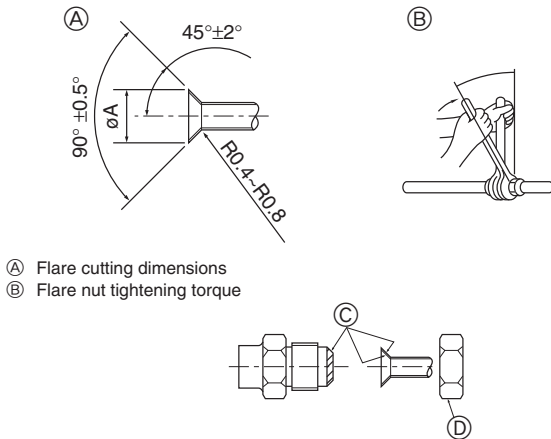

Fig. 4-1



- (A) Flare cutting dimensions
(B) Flare nut tightening torque

Fig. 4-2

(A) (Fig. 4-2)

Copper pipe O.D. (mm)	Flare dimensions øA dimensions (mm)
ø6.35	8.7 - 9.1
ø9.52	12.8 - 13.2
ø12.7	16.2 - 16.6
ø15.88	19.3 - 19.7

(B) (Fig. 4-2)

Copper pipe O.D. (mm)	Flare nut O.D. (mm)	Tightening torque (N·m)
ø6.35	17	14 - 18
ø6.35	22	34 - 42
ø9.52	22	34 - 42
ø12.7	26	49 - 61
ø12.7	29	68 - 82
ø15.88	29	68 - 82
ø15.88	36	100 - 120

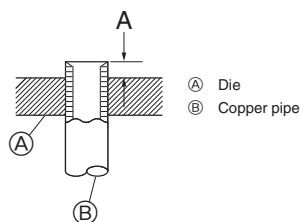

Fig. 4-3

A		(mm)	
PUMY-P100-140	(A) Liquid pipe	(B) Gas pipe	
	ø9.52	ø15.88	
B, C, D			
(C) Total capacity of indoor units		(mm)	
		(A) Liquid pipe	(B) Gas pipe
		ø9.52	ø15.88
a, b, c, d, e, f			
(D) Model number		(A) Liquid pipe	(B) Gas pipe
15, 20, 25, 32, 40, 50		ø6.35	ø12.7
63, 80, 100, 125, 140		ø9.52	ø15.88
(E) Branch kit model			
CMY-Y62-G-E			
(F) 4-Branching header		(G) 8-Branching header	
CMY-Y64-G-E		CMY-Y68-G-E	

4.2. Connecting pipes (Fig. 4-2)

Fig. 4-1 is a sample of piping system.

- When commercially available copper pipes are used, wrap liquid and gas pipes with commercially available insulation materials (heat-resistant to 100°C or more, thickness of 12 mm or more).
- The indoor parts of the drain pipe should be wrapped with polyethylene foam insulation materials (specific gravity of 0.03, thickness of 9 mm or more).
- Apply thin layer of refrigerant oil to pipe and joint seating surface before tightening flare nut. (A)
- Use two wrenches to tighten piping connections. (B)
- Use leak detector or soapy water to check for gas leaks after connections are completed.
- Apply refrigerating machine oil over the entire flare seat surface. (C)
- Use the flare nuts for the following pipe size. (D)

		Indoor unit		Outdoor unit
		15-50	63-140	100-140
Gas side	Pipe size (mm)	ø12.7	ø15.88	ø15.88
Liquid side	Pipe size (mm)	ø6.35	ø9.52	ø9.52

- When bending the pipes, be careful not to break them. Bend radius of 100 mm to 150 mm is sufficient.
- Make sure the pipes do not contact the compressor. Abnormal noise or vibration may result.

- Pipes must be connected starting from the indoor unit. Flare nuts must be tightened with a torque wrench.
 - Flare the liquid pipes and gas pipes and apply a thin layer of refrigeration oil (Applied on site).
- When usual pipe sealing is used, refer to Table 3 for flaring of R410A refrigerant pipes. The size adjustment gauge can be used to confirm A measurements.

Table 3 (Fig. 4-3)

Copper pipe O.D. (mm)	A (mm)	
	Flare tool for R410A	Flare tool for R22-R407C
	Clutch type	
ø6.35 (1/4")	0 - 0.5	1.0 - 1.5
ø9.52 (3/8")	0 - 0.5	1.0 - 1.5
ø12.7 (1/2")	0 - 0.5	1.0 - 1.5
ø15.88 (5/8")	0 - 0.5	1.0 - 1.5
ø19.05 (3/4")	0 - 0.5	1.0 - 1.5

4. Installing the refrigerant piping

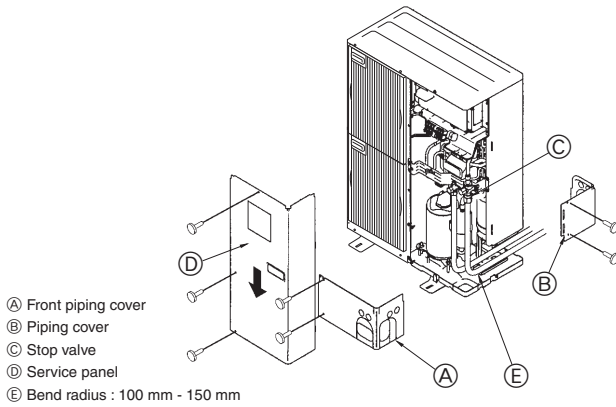

Fig. 4-4

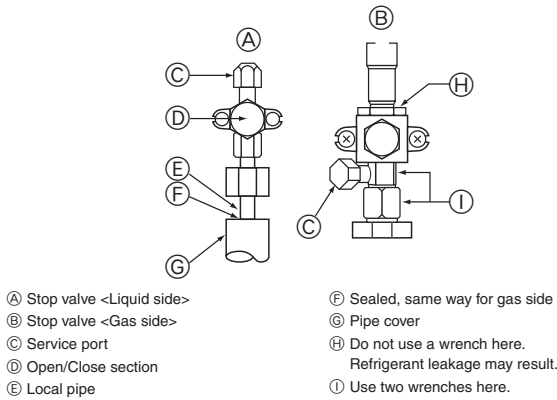

Fig. 4-5

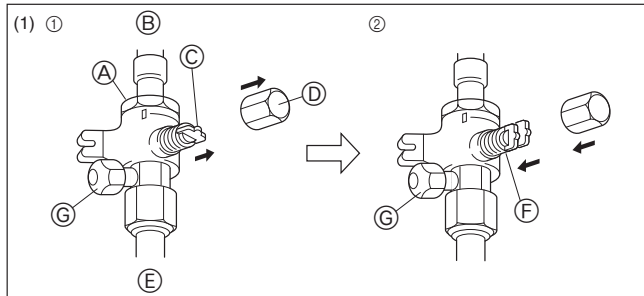

Fig. 4-6

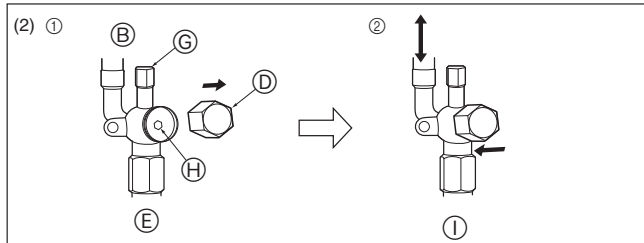

Fig. 4-7

4.3. Refrigerant piping (Fig. 4-4)

Remove the service panel (D) (three screws) and the front piping cover (A) (two screws) and rear piping cover (B) (two screws).

- ① Perform refrigerant piping connections for the indoor/outdoor unit when the outdoor unit's stop valve is completely closed.
 - ② Vacuum-purge air from the indoor unit and the connection piping.
 - ③ After connecting the refrigerant pipes, check the connected pipes and the indoor unit for gas leaks. (Refer to 4.4 Refrigerant pipe airtight testing method)
 - ④ Vacuumize the refrigerant lines through the service port of the liquid and gas stop valves. And then open the stop valves completely (for both the liquid and gas stop valves). This will completely connect the refrigerant lines of the indoor and outdoor units.
 - If the stop valves are left closed and the unit is operated, the compressor and control valves will be damaged.
 - Use a leak detector or soapy water to check for gas leaks at the pipe connection sections of the outdoor unit.
 - Do not use the refrigerant from the unit to purge air from the refrigerant lines.
 - After the valve work is completed, tighten the valve caps to the correct torque: 20 to 25 N·m (200 to 250 kgf·cm).
- Failure to replace and tighten the caps may result in refrigerant leakage. In addition, do not damage the insides of the valve caps as they act as a seal to prevent refrigerant leakage.
- ⑤ Use sealant to seal the ends of the thermal insulation around the pipe connection sections to prevent water from entering the thermal insulation.

4.4. Refrigerant pipe airtight testing method

- (1) Connect the testing tools.
 - Make sure the stop valves (A) (B) are closed and do not open them.
 - Add pressure to the refrigerant lines through the service port (C) of the liquid stop valve (A) and the gas stop valve (B).
- (2) Do not add pressure to the specified pressure all at once; add pressure little by little.
 - ① Pressurize to 0.5 MPa (5 kgf/cm²G), wait five minutes, and make sure the pressure does not decrease.
 - ② Pressurize to 1.5 MPa (15 kgf/cm²G), wait five minutes, and make sure the pressure does not decrease.
 - ③ Pressurize to 4.15 MPa (41.5 kgf/cm²G) and measure the surrounding temperature and refrigerant pressure.
- (3) If the specified pressure holds for about one day and does not decrease, the pipes have passed the test and there are no leaks.
 - If the surrounding temperature changes by 1°C, the pressure will change by about 0.01 MPa (0.1 kgf/cm²G). Make the necessary corrections.
- (4) If the pressure decreases in steps (2) or (3), there is a gas leak. Look for the source of the gas leak.

4.5. Stop valve opening method

- (1) Gas side (Fig. 4-6)
 - ① Remove the cap, pull the handle toward you and rotate 1/4 turn in a counterclockwise direction to open.
 - ② Make sure that the stop valve is open completely, push in the handle and rotate the cap back to its original position.
 - (2) Liquid side (Fig. 4-7)
 - ① Remove the cap and turn the valve rod counterclockwise as far as it will go with the use of a 4 mm hexagonal wrench. Stop turning when it hits the stopper. (ø6.35: Approximately 4.5 revolutions) (ø9.52: Approximately 10 revolutions)
 - ② Make sure that the stop valve is open completely, push in the handle and rotate the cap back to its original position.
- (A) Valve (F) Open position side
 (B) Unit side (G) Service port
 (C) Handle (H) Wrench hole
 (D) Cap (I) Refrigerant flow direction
 (E) Local pipe side

Refrigerant pipes are protectively wrapped

- The pipes can be protectively wrapped up to a diameter of ø90 before or after connecting the pipes. Cut out the knockout in the pipe cover following the groove and wrap the pipes.

Pipe inlet gap

- Use putty or sealant to seal the pipe inlet around the pipes so that no gaps remain. (If the gaps are not closed, noise may be emitted or water and dust will enter the unit and breakdown may result.)

4. Installing the refrigerant piping

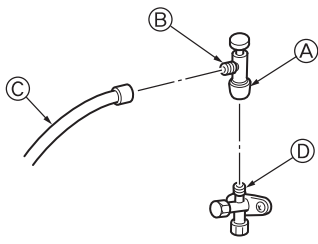

- * The figure to the left is an example only. The stop valve shape, service port position, etc., may vary according to the model.
- * Turn section (A) only. (Do not further tighten sections (A) and (B) together.)

© Charge hose
 ④ Service port

Fig. 4-8

Precautions when using the charge valve (Fig.4-8)

Do not tighten the service port too much when installing it, otherwise, the valve core could be deformed and become loose, causing a gas leak.
 After positioning section (B) in the desired direction, turn section (A) only and tighten it. Do not further tighten sections (A) and (B) together after tightening section (A).

4.6. Additional refrigerant charge

Refrigerant of 3 kg equivalent to 50 m total extended piping length is already included when the outdoor unit is shipped. Thus, if the total extended piping length is 50 m or less, there is no need to charge with additional refrigerant.

Calculation of Additional Refrigerant Charge

- If the total extended piping length exceeds 50 m, calculate the required additional refrigerant charge using the procedure shown below.
- If the calculated additional refrigerant charge is a negative amount, do not charge with any refrigerant.

<Additional Charge>

Additional refrigerant charge	=	Liquid pipe size Total length of ø9.52 × 0.06	+	Liquid pipe size Total length of ø6.35 × 0.024	-	Refrigerant amount for outdoor unit
(kg)		(m) × 0.06 (kg/m)		(m) × 0.024 (kg/m)		3.0 kg

<Example>

Outdoor model : 125

Indoor 1 : 63 A : ø9.52 30 m

2 : 40 a : ø9.52 15 m

3 : 25 b : ø6.35 10 m

4 : 20 c : ø6.35 10 m

d : ø6.35 20 m

At the conditions below:

The total length of each liquid line is as follows

ø9.52 : A + a = 30 + 15 = 45 m

ø6.35 : b + c + d = 10 + 10 + 20 = 40 m

Therefore,

<Calculation example>

Additional refrigerant charge

= 45 × 0.06 + 40 × 0.024 - 3.0 = 0.7 kg (rounded up)

5. Drainage piping work

Outdoor unit drainage pipe connection

When drain piping is necessary, use the drain socket or the drain pan (option).

	P100-140
Drain socket	PAC-SG61DS-E
Drain pan	PAC-SG64DP-E

6. Electrical work

6.1. Caution

- Follow ordinance of your governmental organization for technical standard related to electrical equipment, wiring regulations and guidance of each electric power company.
- Wiring for control (hereinafter referred to as transmission line) shall be (5 cm or more) apart from power source wiring so that it is not influenced by electric noise from power source wiring. (Do not insert transmission line and power source wire in the same conduit.)
- Be sure to provide designated grounding work to outdoor unit.
- Give some allowance to wiring for electrical part box of indoor and outdoor units, because the box is sometimes removed at the time of service work.
- Never connect the main power source to terminal block of transmission line. If connected, electrical parts will be burnt out.
- Use 2-core shield cable for transmission line. If transmission lines of different systems are wired with the same multiplecore cable, the resultant poor transmitting and receiving will cause erroneous operations.
- Only the transmission line specified should be connected to the terminal block for outdoor unit transmission.
 (Transmission line to be connected with indoor unit : Terminal block TB3 for transmission line, Other : Terminal block TB7 for centralized control)
 Erroneous connection does not allow the system to operate.
- In case to connect with the upper class controller or to conduct group operation in different refrigerant systems, the control line for transmission is required between the outdoor units each other.
 Connect this control line between the terminal blocks for centralized control. (2-wire line with no polarity)
 When conducting group operation in different refrigerant systems without connecting to the upper class controller, replace the insertion of the short circuit connector from CN41 of one outdoor unit to CN40.
- Group is set by operating the remote controller.

6. Electrical work

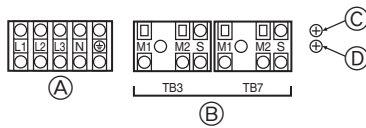

- Ⓐ : Power source
 Ⓑ : Transmission line
 Ⓒ : Screw on the electrical component box
 Ⓓ : Screw on the electrical component box

Fig. 6-1

6.2. Control box and connecting position of wiring (Fig. 6-1)

- Connect the indoor unit transmission line to transmission terminal block (TB3), or connect the wiring between outdoor units or the wiring with the centralized control system to the centralized control terminal block (TB7).
 When using shielded wiring, connect shield ground of the indoor unit transmission line to the screw (Ⓒ or Ⓓ) and connect shield ground of the line between outdoor units and the central control system transmission line to the shield (S) terminal of the centralized control terminal block (TB7) shield (S) terminal. In addition, in the case of outdoor units whose power supply connector CN41 has been replaced by CN40, the shield terminal (S) of terminal block (TB7) of the centralized control system should also be connected to the screw Ⓒ or Ⓓ using attached lead wire.
- Conduit mounting plates (φ27) are being provided. Pass the power supply and transmission wires through the appropriate knock-out holes, then remove the knock-out piece from the bottom of the terminal box and connect the wires.
- Fix power source wiring to terminal box by using buffer bushing for tensile force (PG connection or the like).

6.3. Wiring transmission cables

① Types of control cables

1. Wiring transmission cables

- Types of transmission cables: Shielding wire CVVS or CPEVS or MVVS
- Cable diameter: More than 1.25 mm²
- Maximum wiring length: Within 200 m

2. M-NET Remote control cables

Kind of remote control cable	Sheathed 2-core cable (unshielded) CVV
Cable diameter	0.3 to 1.25 mm ² (0.75 to 1.25 mm ²)*
Remarks	When 10 m is exceeded, use cable with the same specifications as 1. Wiring transmission cables.

* Connected with simple remote controller.

3. MA Remote control cables

Kind of remote control cable	Sheathed 2-core cable (unshielded) CVV
Cable diameter	0.3 to 1.25 mm ² (0.75 to 1.25 mm ²)*
Remarks	Within 200 m

* Connected with simple remote controller.

② Wiring examples

- Controller name, symbol and allowable number of controllers.

Name	Symbol	Allowable number of controllers	
Outdoor unit controller	OC	-	
Indoor unit controller	IC	PUMY-P100	1 to 8 units per 1 OC
		PUMY-P125	1 to 10 units per 1 OC
		PUMY-P140	1 to 12 units per 1 OC
Remote controller	RC	RC (M-NET)	Maximum of 12 controllers for 1 OC
		MA	Maximum of 2 per group

Example of a group operation system with multiple outdoor units (Shielding wires and address setting are necessary.)

<Examples of Transmission Cable Wiring>

■ M-NET Remote Controller (Fig. 6-2)

■ MA Remote Controller (Fig. 6-3)

<Wiring Method and Address Settings>

- Always use shielded wire when making connections between the outdoor unit (OC) and the indoor unit (IC), as well for all OC-OC, and IC-IC wiring intervals.
- Use feed wiring to connect terminals M1 and M2 and the ground terminal on the transmission cable terminal block (TB3) of each outdoor unit (OC) to terminals M1, M2 and terminal S on the transmission cable block of the indoor unit (IC).
- Connect terminals 1 (M1) and 2 (M2) on the transmission cable terminal block of the indoor unit (IC) that has the most recent address within the same group to the terminal block on the remote controller (RC).
- Connect together terminals M1, M2 and terminal S on the terminal block for central control (TB7) for the outdoor unit (OC).
- The jumper connector CN41 on the control panel does not change.
- Connect shield ground of the indoor units transmission line to the shield (S) terminal of (TB3) and also connect (S) terminal to screw Ⓒ or Ⓓ using attached lead wire. Connect shield ground of the line between outdoor units and the central control system transmission line to the shield (S) terminal of (TB7).
- Set the address setting switch as follows.

Unit	Range	Setting Method
IC (Main)	01 to 50	Use the most recent address within the same group of indoor units
IC (Sub)	01 to 50	Use an address, other than that of the IC (Main) from among the units within the same group of indoor units. This must be in sequence with the IC (Main)
Outdoor Unit	51 to 100	Use the most recent address of all the indoor units plus 50 * The address automatically becomes "100" if it is set as "01 - 50".
M-NET R/C (Main)	101 to 150	Set at an IC (Main) address within the same group plus 100
M-NET R/C (Sub)	151 to 200	Set at an IC (Main) address within the same group plus 150
MA R/C	-	Unnecessary address setting (Necessary main/sub setting)

- The group setting operations among the multiple indoor units is done by the remote controller (RC) after the electrical power has been turned on.

<Permissible Lengths>

① M-NET Remote controller

- Max length via outdoor units: L₁+L₂+L₃+L₄ and L₁+L₂+L₃+L₅ and L₁+L₂+L₆+L₇ ≤ 500 m (1.25 mm² or more)
- Max transmission cable length: L₁ and L₃+L₄ and L₃+L₅ and L₆ and L₂+L₆ and L₇ ≤ 200 m (1.25 mm² or more)
- Remote controller cable length: ℓ₁, ℓ₂, ℓ₂+ℓ₃, ℓ₄ ≤ 10 m (0.5 to 1.25 mm²)
 If the length exceeds 10 m, use a 1.25 mm² shielded wire. The length of this section (L₃) should be included in the calculation of the maximum length and overall length.

② MA Remote controller

- Max length via outdoor unit (M-NET cable): L₁+L₂+L₃+L₄ and L₁+L₂+L₆+L₇ ≤ 500 m (1.25 mm² or more)
- Max transmission cable length (M-NET cable): L₁ and L₃+L₄ and L₆ and L₂+L₆ and L₇ ≤ 200 m (1.25 mm² or more)
- Remote controller cable length: m₁ and m₁+m₂+m₃ and m₁+m₂+m₃+m₄ ≤ 200 m (0.3 to 1.25 mm²)

6. Electrical work

■ M-NET Remote Controller

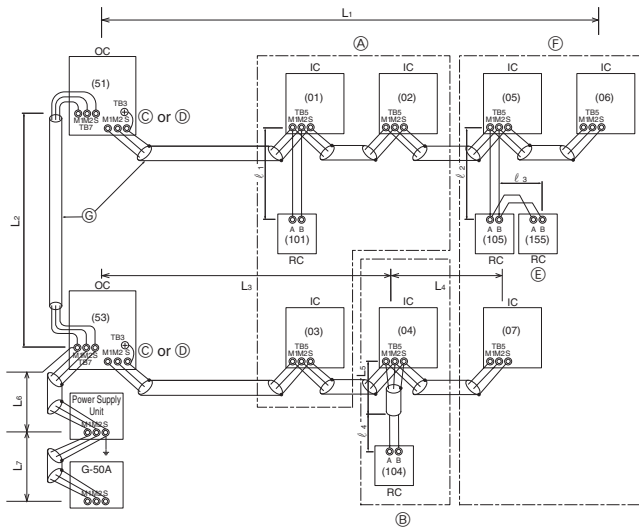

Fig. 6-2

- (A) : Group 1
 (B) : Group 3
 (C) : Screw on the electrical component box
 (D) : Screw on the electrical component box
 (E) : Sub Remote Controller
 (F) : Group 5
 () : Address

■ MA Remote Controller

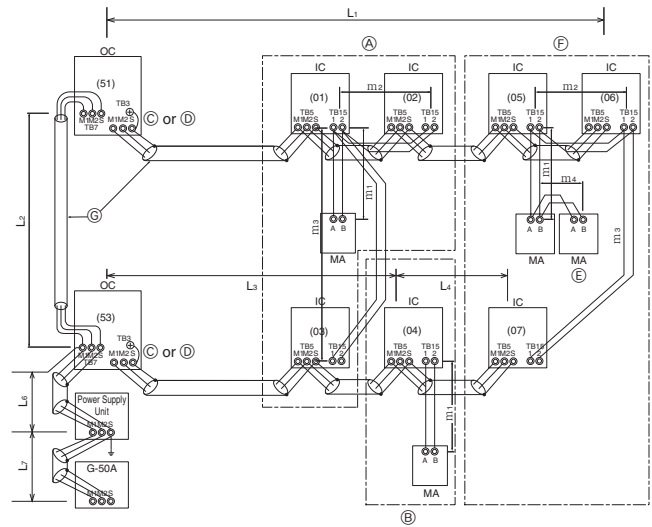

Fig. 6-3

6.4. Wiring of main power supply and equipment capacity

Schematic Drawing of Wiring (Example) (Fig. 6-4)

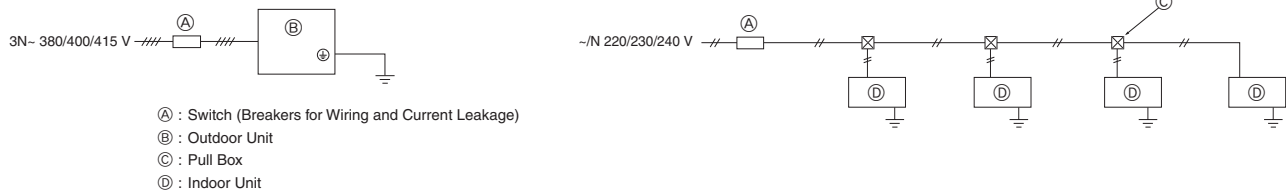

Fig. 6-4

Thickness of Wire for Main Power Supply and On/Off Capacities

Model	Power Supply	Minimum Wire Thickness (mm ²)			Breaker for Wiring*1	Breaker for Current Leakage
		Main Cable	Branch	Ground		
Outdoor Unit	P100-140	3N-380/400/415 V, 50 Hz	1.5	—	16 A	16 A 30 mA 0.1 sec. or less
Indoor Unit		~N 220/230/240 V, 50 Hz	1.5	1.5	15 A	15 A 30 mA 0.1 sec. or less

*1. A breaker with at least 3.0 mm contact separation in each poles shall be provided. Use non-fuse breaker (NF) or earth leakage breaker (NV).

1. Use a separate power supply for the outdoor unit and indoor unit.
2. Bear in mind ambient conditions (ambient temperature, direct sunlight, rain water, etc.) when proceeding with the wiring and connections.
3. The wire size is the minimum value for metal conduit wiring. The power cord size should be 1 rank thicker consideration of voltage drops. Make sure the power-supply voltage does not drop more than 10%.
4. Specific wiring requirements should adhere to the wiring regulations of the region.
5. Power supply cords of parts of appliances for outdoor use shall not be lighter than polychloroprene sheathed flexible cord (design 60245 IEC57). For example, use wiring such as YZW.
6. Install an earth longer than other cables.

⚠ Warning:

- Be sure to use specified wires to connect so that no external force is imparted to terminal connections. If connections are not fixed firmly, it may cause heating or fire.
- Be sure to use the appropriate type of overcurrent protection switch. Note that generated overcurrent may include some amount of direct current.

⚠ Caution:

- Some installation site may require attachment of an earth leakage breaker. If no earth leakage breaker is installed, it may cause an electric shock.
- Do not use anything other than breaker and fuse with correct capacity. Using fuse and wire or copper wire with too large capacity may cause a malfunction of unit or fire.

IMPORTANT

Make sure that the current leakage breaker is one compatible with higher harmonics. Always use a current leakage breaker that is compatible with higher harmonics as this unit is equipped with an inverter. The use of an inadequate breaker can cause the incorrect operation of inverter.

7. Test run

7.1. Before test run

- ▶ After completing installation and the wiring and piping of the indoor and outdoor units, check for refrigerant leakage, looseness in the power supply or control wiring, wrong polarity, and no disconnection of one phase in the supply.
- ▶ Use a 500-volt M-ohm tester to check that the resistance between the power supply terminals and ground is at least 1 MΩ.
- ▶ Do not carry out this test on the control wiring (low voltage circuit) terminals.

⚠ **Warning:**

Do not use the air conditioner if the insulation resistance is less than 1 MΩ.

Insulation resistance

After installation or after the power source to the unit has been cut for an extended period, the insulation resistance will drop below 1 MΩ due to refrigerant accumulating in the compressor. This is not a malfunction. Perform the following procedures.

1. Remove the wires from the compressor and measure the insulation resistance of the compressor.
2. If the insulation resistance is below 1 MΩ, the compressor is faulty or the resistance dropped due to the accumulation of refrigerant in the compressor.

3. After connecting the wires to the compressor, the compressor will start to warm up after power is supplied. After supplying power for the times indicated below, measure the insulation resistance again.

- The insulation resistance drops due to accumulation of refrigerant in the compressor. The resistance will rise above 1 MΩ after the compressor is warmed up for four hours.
(The time necessary to warm up the compressor varies according to atmospheric conditions and refrigerant accumulation.)
- To operate the compressor with refrigerant accumulated in the compressor, the compressor must be warmed up at least 12 hours to prevent breakdown.

4. If the insulation resistance rises above 1 MΩ, the compressor is not faulty.

⚠ **Caution:**

• **The compressor will not operate unless the power supply phase connection is correct.**

• **Turn on the power at least 12 hours before starting operation.**

- Starting operation immediately after turning on the main power switch can result in severe damage to internal parts. Keep the power switch turned on during the operational season.

▶ **The followings must be checked as well.**

- The outdoor unit is not faulty. LED on the control board of the outdoor unit flash when the outdoor unit is faulty.
- Both the gas and liquid stop valves are completely open.

7.2. Test run

7.2.1. Using remote controller

Refer to the indoor unit installation manual.

- Be sure to perform the test run for each indoor unit. Make sure each indoor unit operates properly following the installation manual attached to the unit.
- If you perform the test run for all indoor units at once, you cannot detect any erroneous connection, if any, of the refrigerant pipes and the connecting wires.
- * The compressor operation is not available for 3 minutes at least after the power is supplied.
- The compressor can emit noise just after turn on the power supply or in case of low outside air temperature.

About the restart protective mechanism

Once the compressor stops, the restart preventive device operates so the compressor will not operate for 3 minutes to protect the air conditioner.

7.2.2. Using SW3 in outdoor unit

Note:

In case of the test run from outdoor unit, all indoor units operate. Therefore, you can not detect any erroneous connection of refrigerant pipes and the connecting wires. If it aims at detection of any erroneous connection, be sure to carry out the test run from remote controller with reference to “7.2.1 Using remote controller.”

SW3-1	ON	Cooling operation
SW3-2	OFF	
SW3-1	ON	Heating operation
SW3-2	ON	

* After performing the test run, set SW3-1 to OFF.

- A few seconds after the compressor starts, a clanging noise may be heard from the inside of the outdoor unit. The noise is coming from the check valve due to the small difference in pressure in the pipes. The unit is not faulty.

The test run operation mode cannot be changed by DIP switch SW3-2 during the test run. (To change the test run operation mode during the test run, stop the test run by DIP switch SW3-1. After changing the test run operation mode, resume the test run by switch SW3-1.)

7.3. Refrigerant collecting (Pump down)

Before removing air conditioners for transfer to another location, always close the stop valve (for both liquid and gas pipes) located at the outdoor unit, then remove the indoor and outdoor units. At this time, the refrigerant in the indoor unit will be discharged. To minimize the refrigerant discharged, a pump down operation is required. This operation collects the refrigerant present inside the air conditioner and sends it into the heat exchanger located in the outdoor unit.

Pump down procedure

- ① Operate all indoor units in cooling mode and check that the operation mode has changed to “COOL”. (Set the units so that cooling operation mode is activated during the pump down operation (when the TEST RUN button is pressed).)
- ② Connect a gauge manifold valve (with pressure gauge) to the stop valve of the gas pipe, to enable measurement of refrigerant pressure.
- ③ After setting the outdoor service switch SW3-2 to OFF, set the switch SW3-1 to ON. (The unit will start in cooling mode.)
- ④ After the cooling operation has been carried out for approximately five minutes, set the outdoor service switch SW2-4 (pump down switch) from OFF to ON.
- ⑤ Close the stop valve on the liquid pipe, with the cooling operation still ON. (Pump down operation will start.)
- ⑥ When the reading of the pressure gauge reaches 0 to 0.1 MPa (0 to 1 kg/cm²G) or when approximately 5 minutes have elapsed following the start of the pump down operation, fully close the stop valve on the gas pipe and stop the air conditioner by setting the switch SW3-1 to OFF immediately.

⑦ Set the outdoor service switch SW2-4 from ON to OFF.

⑧ Remove the gauge manifold valve and put the cap back onto each stop valve.

Note:

- ① **Never carry out pump down operation if the amount of refrigerant inside the indoor unit is larger than the amount of charge-less refrigerant. Carrying out a pump down operation when the amount of refrigerant exceeds the amount of charge-less refrigerant will cause an extreme pressure rise and may result in an accident.**
- ② **Do not continue to operate for a long time with the switch SW2-4 set to ON. Make sure to switch it to OFF after pump down is completed.**
- ③ **Test run can be carried out when the test run switch SW3-1 is ON. Switch SW3-2 is used to operating mode selection. (ON: Heating, OFF: Cooling)**
- ④ **Time required for a pump down operation is three to five minutes after the stop valve on the liquid pipe has been closed. (It depends on the ambient temperature and amount of refrigerant inside the indoor unit.)**
- ⑤ **Ensure that the reading of the pressure gauge does not drop below 0 MPa (0 kg/cm²G). If it drops 0 MPa (0 kg/cm²G) (i.e. vacuum is created), air will be drawn into the unit if there are any loose connections.**
- ⑥ **Even if the reading of the pressure gauge does not drop below 0 MPa (0 kg/cm²G), always stop the pump down operation within approximately five minutes after the stop valve on the liquid pipe has been fully closed.**