



INSTALLATION MANUAL

SPLIT-TYPE AIR CONDITIONERS Models

MS-GA60/80VB Series
MSH-GA60/71/80VB
[FLARE CONNECTION TYPE]



When installing an MXZ series outdoor unit, refer to the MS and MSH type manual for indoor unit set up.

IMPORTANT NOTES

TO COMPLY WITH THE REQUIREMENT OF AUSTRALIAN STANDARD AS/NZS 3000 ELECTRICAL INSTALLATIONS (Wiring Rules), THE ELECTRICAL WIRING REQUIRED BETWEEN THE INDOOR AND OUTDOOR UNITS MUST BE INSTALLED BY A LICENCED ELECTRICAL CONTRACTOR.

1. THE FOLLOWING SHOULD ALWAYS BE OBSERVED FOR SAFETY

- Be sure to read "THE FOLLOWING SHOULD ALWAYS BE OBSERVED FOR SAFETY" before installing the air conditioner.
- Be sure to observe the cautions specified here as they include important items related to safety.
- The indications and meanings are as follows.

⚠ WARNING

Could lead to death, serious injury, etc.

⚠ CAUTION

Could lead to serious injury in particular environments when operated incorrectly.

- After reading this manual, be sure to keep it together with the OPERATING INSTRUCTIONS in a handy place on the customer's site.

⚠ WARNING

- **Do not install the unit by yourself (customer).**
Incomplete installation could cause injury due to fire, electric shock, the unit falling or leakage of water. Consult the dealer from whom you purchased the unit or special installer.
- **Install the unit securely in a place which can bear the weight of the unit.**
When installed in an insufficient strong place, the unit could fall causing injury.
- **Use the specified wires to connect the indoor and outdoor units securely and attach the wires firmly to the terminal block connecting sections so the stress of the wires is not applied to the sections.**
Incomplete connecting and fixing could cause fire.
- **Do not use intermediate connection of the power cord or the extension cord and do not connect many devices to one AC outlet.**
It could cause a fire or an electric shock due to defective contact, defective insulation, exceeding the permissible current, etc.
- **Check that the refrigerant gas do not leak after installation has completed.**
If refrigerant gas leaks indoors, and comes into contact with the fire of a fan heater, space heater, stove, etc., harmful substances will be generated.
- **Perform the installation securely referring to the installation manual.**
Incomplete installation could cause a personal injury due to fire, electric shock, the unit falling or leakage of water.
- **Perform electrical work according to the installation manual and be sure to use an exclusive circuit.**
If the capacity of the power circuit is insufficient or there is incomplete electrical work, it could result in a fire or an electric shock.
- **Attach the electrical cover to the indoor unit and the service panel to the outdoor unit securely.**
If the electrical cover in the indoor unit and/or the service panel in the outdoor unit are not attached securely, it could result in a fire or an electric shock due to dust, water, etc.
- **Be sure to use the part provided or specified parts for the installation work.**
The use of defective parts could cause an injury or leakage of water due to a fire, an electric shock, the unit falling, etc.
- **Be sure to cut off the main power in case of setting up the indoor electronic control P.C. board or wiring works.**
It could cause an electric shock.
- **The appliance shall be installed in accordance with national wiring regulations.**
- **When installing or relocating the unit, make sure that no substance other than the specified refrigerant (R410A) enters the refrigerant circuit.**
Any presence of foreign substance such as air can cause abnormal pressure rise or an explosion.

⚠ CAUTION

- **Earth the unit.**
Do not connect the earth to a gas pipe, water pipe, lightning rod or telephone earth. Defective earthing could cause an electric shock.
- **Do not install the unit in a place where an inflammable gas leaks.**
If gas leaks and accumulates in the area surrounding the unit, it could cause an explosion.
- **Install an earth leakage breaker depending on the installation place (Where it is humid).**
If an earth leakage breaker is not installed, it could cause an electric shock.
- **Perform the drainage/piping work securely according to the installation manual.**
If there is a defect in the drainage/piping work, water could drop from the unit and household goods could be wet and damaged.
- **Fasten a flare nut with a torque wrench as specified in this manual.**
When fastened too tight, a flare nut may broken after a long period and cause a leakage of refrigerant.

2. SELECTING THE INSTALLATION LOCATION

2-1 INDOOR UNIT

- Where airflow is not blocked.
- Where cool air spreads over the entire room.
- Maximum refrigerant piping length between indoor unit and outdoor unit is 25 m (for 60 type) and 30 m (for 71/80 type) and the difference of height of both units is 10 m (for 60 type) and 15 m (for 71/80 type).
- Rigid wall without vibration.
- Where it is not exposed to direct sunshine.
- Where easily drained.
- At a distance 1 m or more away from your TV and radio. Operation of the air conditioner interferes with radio or TV reception in areas where reception is weak. An amplifier may be required for the affected device.
- In a place as far away as possible from fluorescent and incandescent lights (so the infrared remote control can operate the air conditioner normally).
- Where the air filter can be removed and replaced easily.

2-2 OUTDOOR UNIT

- Where it is not exposed to strong wind.
- Where airflow is good and dustless.
- Where it is not exposed to rain and direct sunshine.
- Where neighbours are not annoyed by operation sound or hot air.
- Where rigid wall or support is available to prevent the increase of operation sound or vibration.
- Where there is no risk of combustible gas leakage.
- When installing the unit at a high level, be sure to fix the unit legs.
- Where it is at least 3 m away from the antenna of TV set or radio. Operation of the air conditioner may interfere with radio or TV reception in areas where reception is weak. An amplifier may be required for the affected device.
- Install the unit horizontally.
- Please install it in an area not affected by snowfall or blowing snow. In areas with heavy snow, please install a canopy, a pedestal and/or some baffle boards.

Note:

It is advisable to make a piping loop near outdoor unit so as to reduce vibration transmitted from there.

⚠ CAUTION

Avoid the following places for installation where air conditioner trouble is liable to occur.

- Where flammable gas could leak.
- Where there is much machine oil.
- Salty places such as the seaside.
- Where sulfide gas is generated such as a hot spring.
- Where there is high-frequency or wireless equipment.

2-3 WIRELESS REMOTE CONTROLLER MOUNTING

- Place of mounting
 - Where it is easy to operate and easily visible.
 - Where children can not touch.
- Mounting
Select a position about 1.2 m above the floor, check that signals from the remote controller are surely received by the indoor unit from that position ('beep' or 'beep-beep' receiving tone sounds). After that, attach remote controller holder ③ to a pillar or wall and set the wireless remote controller ⑥.

In rooms where inverter type fluorescent lamps are used, the signal from the wireless remote controller may not be received.

3. INSTALLATION DIAGRAM & ACCESSORIES

FLARED CONNECTIONS

- This unit has flared connections on both indoor and outdoor sides.
- Remove the outdoor units valve cover, then connect the pipe.
- Refrigerant pipes are used to connect the indoor and outdoor units.
- Be careful not to crush or bend the pipe in pipe bending.

Limits	MS-GA60 MSH-GA60	MS-GA80 MSH-GA71/80
Pipe length	25 m max.	30 m max.
Height difference	10 m max.	15 m max.
No. of bends	10 max.	

- Refrigerant adjustment ... If pipe length exceeds 7 m, additional refrigerant (R410A) charge is required.
(The outdoor unit is charged with refrigerant for pipe length up to 7 m.)

Pipe length	Up to 7 m	No additional charge is required.
	Exceeding 7 m	Additional charge is required. (Refer to the table below.)
Refrigerant to be added	MS-GA80	55 g/m × (refrigerant piping length (m) - 7)
	MSH-GA71/80	55 g/m × (refrigerant piping length (m) - 7)
	MS-GA60 MSH-GA60	20 g/m × (refrigerant piping length (m) - 7)

ACCESSORIES

Check the following parts before installation.
<Indoor unit>

1	Installation plate	1
2	Installation plate fixing screw 4 × 25 mm	7
3	Remote controller holder	1
4	Fixing screw for 3 3.5 × 16 mm (Black)	2
5	Battery (AAA) for remote controller	2
6	Wireless remote controller	1
7	Felt tape (Used for left or left-rear piping)	1
8	Air cleaning filter	2

PART TO BE PROVIDED AT YOUR SITE

Optional extension pipe

A	Indoor/outdoor unit connecting wire (2-core 1.0 mm ² -2.0 mm ²)	1
B	Extension pipe	1
C	Wall hole sleeve	1
D	Wall hole cover	1
E	Pipe fixing band (The quantity depends on the pipe length.)	2 to 5
F	Fixing screw for E 4 × 20 mm (The quantity depends on the pipe length.)	2 to 5
G	Piping tape	1
H	Putty	1
I	Drain hose (or soft PVC. hose, 15 mm inner dia.)	1
J	Refrigeration oil	1
K	Power supply cord (See the table in 5 INDOOR/OUTDOOR WIRE CONNECTION AND OUTDOOR POWER SUPPLY CORD CONNECTION for the cord size.)	1

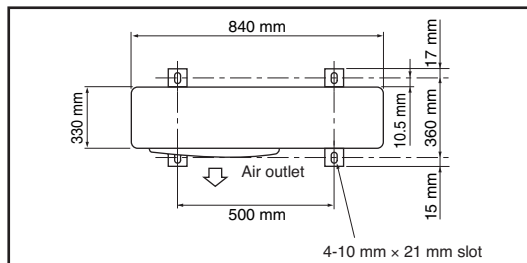

- Note:**
When operating the air conditioner in low outside temperature, be sure to follow the instructions described below.
- Never install the outdoor unit in a place where its air inlet/outlet side may be exposed directly to wind.
 - To prevent exposure to wind, install the outdoor unit with its air inlet side facing the wall.
 - To prevent exposure to wind, it is recommended to install a baffle board on the air outlet side of the outdoor unit.

PIPING PREPARATION

- 1 Specifications
Use the refrigerant pipes that meet the following specifications.

Pipe		Outside diameter	Insulation thickness	Insulation material
		mm	mm	
For liquid	MS-GA60	6.35	8	Heat resisting foam plastic 0.045 specific gravity
	MSH-GA60			
	MS-GA80	9.52	8	
	MSH-GA71/80			
For gas		15.88	8	

- Use a copper pipe or a copper-alloy seamless pipe with a thickness of 0.8 mm (for ø6.35, 9.52) or 1.0 mm (for ø15.88). Never use any pipe with a thickness less than 0.8 mm (for ø6.35, 9.52) or 1.0 mm (for ø15.88), as the pressure resistance is insufficient.
- 2 Ensure that the 2 refrigerant pipes are insulated to prevent condensation.
- 3 Refrigerant pipe bending radius must be 100 mm or more.

CAUTION

Be sure to use the insulation of specified thickness. Excessive thickness may cause incorrect installation of the indoor unit and lack of thickness may cause dew drippage.

Decide the installation position using mark on the installation plate indicating the indoor unit size as reference.

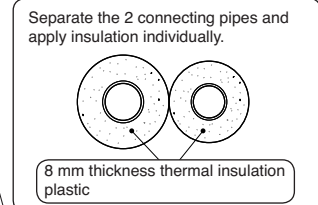
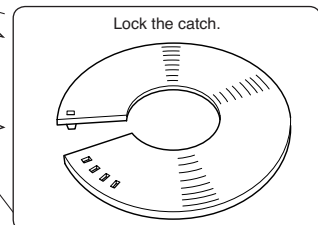
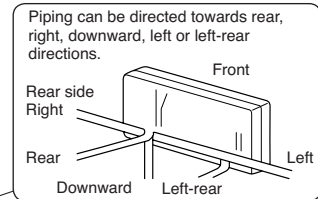
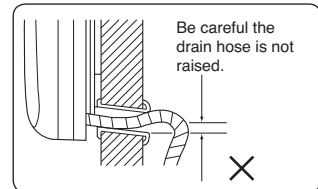
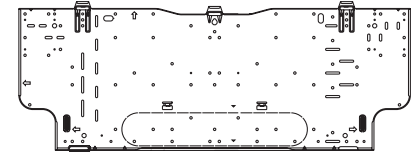

When the piping is to be attached to a wall containing metals (tin plated) or metal netting, use a chemically treated wooden piece 20 mm or thicker between the wall and the piping or wrap 7 to 8 turns of insulation vinyl tape around the piping.

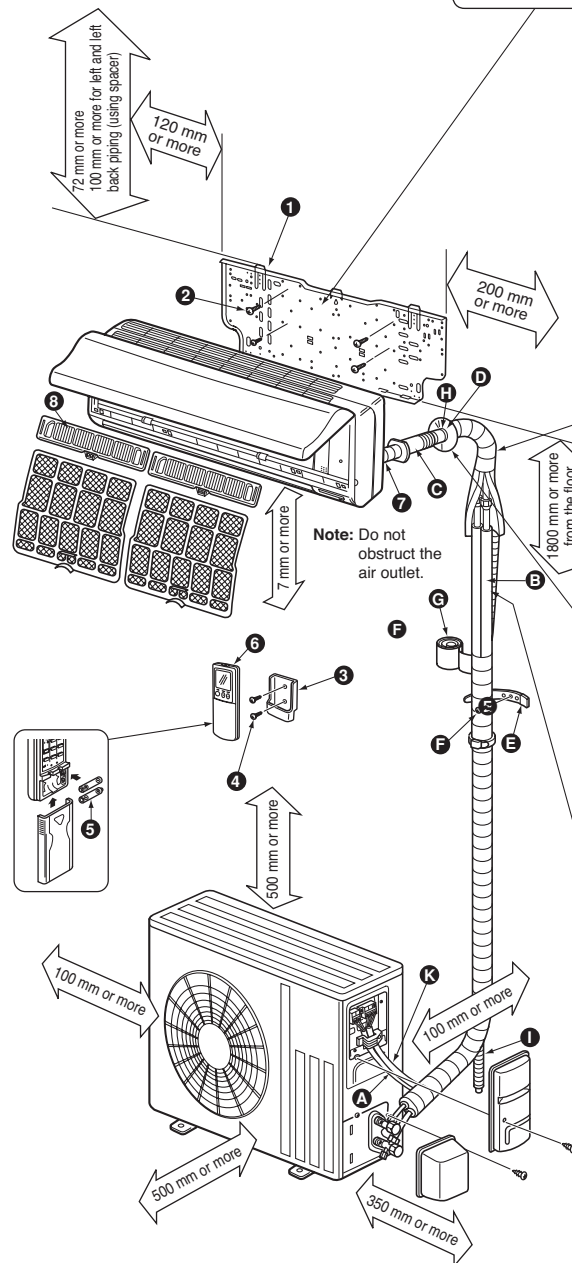

Units should be installed by licensed contractor according to local code requirement.

4. INDOOR UNIT INSTALLATION

4-1 FIXING OF INSTALLATION PLATE

- Find a structural material (such as a stud) in the wall and fix installation plate horizontally.

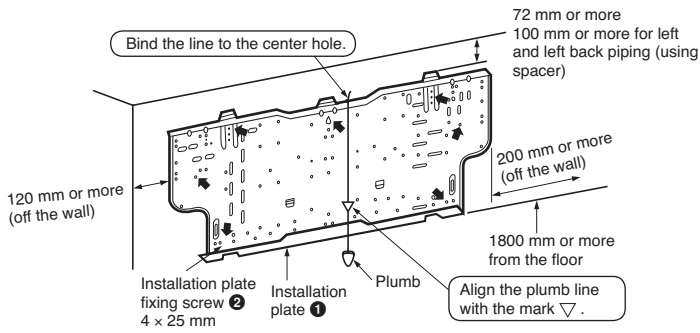

To prevent the installation plate from vibrating, be sure to fix the holes as indicated by the arrows **f**.

When bolts recessed in the concrete wall are to be utilized, secure the installation plate **1** using 11 × 20 · 11 × 26 oval hole (450 mm pitch). If the recessed bolt is too long, change it for a shorter one available in the market.

4-2 WALL HOLE DRILLING

- Determine the wall hole position.
- Drill a 75 mm hole so that outside can be lower than inside.
- Insert the wall hole sleeve **c**.

Positioning of the holes on the wall

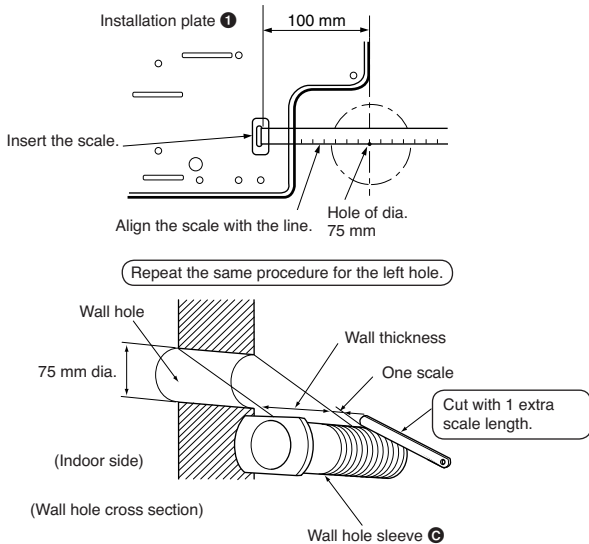

Be sure to use wall hole sleeve **c** to prevent the outdoor connecting wires from contacting with metal part in the wall and to prevent damage by rat in case the wall is hollow.

Wall hole sealing and fixing pipe to wall

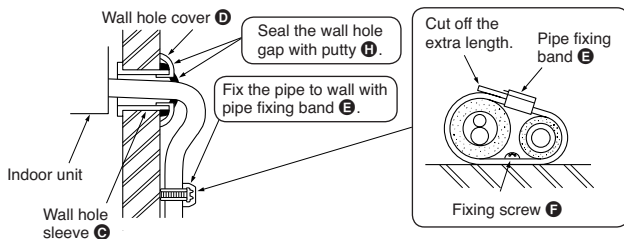

4-3 CONNECTING WIRE SPECIFICATIONS

- Use special room air conditioning circuit.

Power supply cord length (Lead to left/Lead to right)	1 m/2 m
Indoor/outdoor unit connecting wire Specification	Cable 2-core 1.0 mm ² , in conformity with Design 60245 IEC 57.

- Take out power supply cord from the left or right bottom corner of the indoor unit.

Connect to the power switch which has a gap of 3 mm or more when open to interrupt the source power phase.
(When the power switch is shut off, it must interrupt all phases.)
(Rated Voltage/Frequency : 230 V/50 Hz)
(Input capacity Main switch/Fuse : 10 A)
(This plug has to be the one meets the Standards.)

WARNING

Never cut the indoor and outdoor unit connecting wire and connect it to other wires. It may cause a fire.

Do not bundle the spare wire, but put it as shown below.

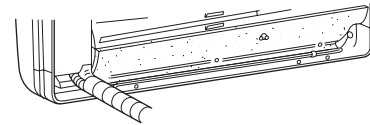

4-4 INDOOR AND OUTDOOR CONNECTING WIRE CONNECTION

You can connect indoor/outdoor lead wire without removing the front panel.

- Open the front panel.
- Remove one screw holding the electrical cover, then remove the cover.
- Remove the VA clamp and the cord clamp.
- Pass the indoor/outdoor unit connecting wire from the back of the indoor unit and process the end of the wire, then connect it to the terminal block.
- Replace the fixture and electrical cover securely.

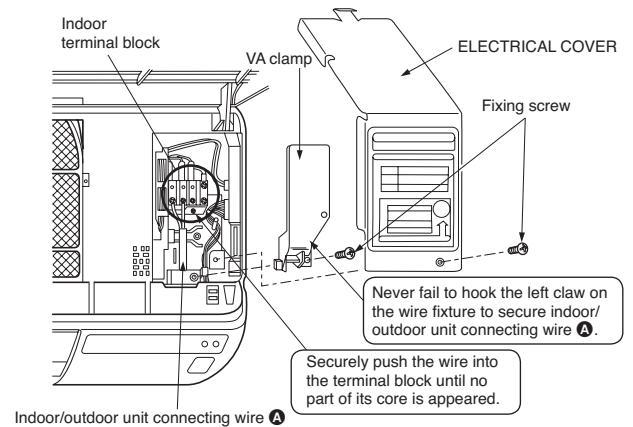

WARNING

- Use the indoor/outdoor unit connecting wire that meets the Standards to connect the indoor and outdoor units and fix the wire to the terminal block securely so that no external force is conveyed to the connecting section of the terminal block. Incomplete connection or fixing of the wire could result in a fire.
- Attach the electrical cover securely. If it is attached incorrectly, it could result in a fire or an electric shock due to dust, water, etc.

MS Type and MSH Type

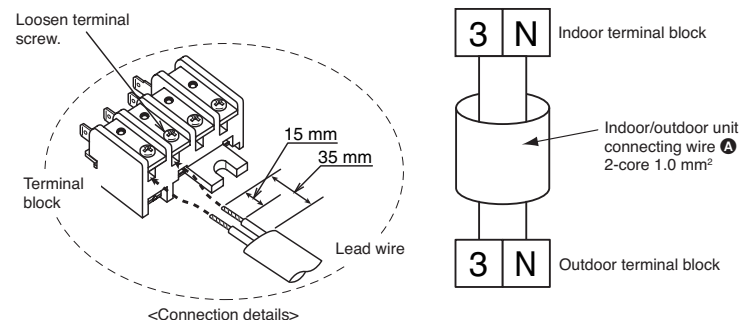

CAUTION

- Be careful not to make mis-wiring.
- Firmly tighten the terminal screws to prevent them from loosening.
- After tightening, pull the wires lightly to confirm that they do not move.
- If the connecting wire is incorrectly connected to the terminal block, the unit does not operate normally.
- If an earth is incorrect, it may cause an electric shock.

4-5 AUTO RESTART FUNCTION

- These models are equipped with an auto restart function. If you do not want to use this function, please consult the service representative because the setting of the unit needs to be changed.
- When the indoor unit is controlled with the remote controller, the operation mode, the set temperature, and the fan speed are memorized by the indoor electronic control P.C. board. The auto restart function sets to work the moment the power has restored after power failure, then, the unit will restart automatically. If the unit is operated in "I FEEL..." or "AUTO" mode before power failure, the operation mode (COOL, DRY or HEAT) is not stored in the memory. When the main power is turned on, the unit decides the operation mode by the initial room temperature at restart and starts operation again.

Operation

- ① If the main power (230V AC) has been cut, the operation settings remain.
- ② When three minutes have passed after power was restored, the unit will restart automatically according to the memory.

Notes:

- The operation settings are memorized when 10 seconds have passed after the remote controller was operated.
- If the main power is turned off or a power failure occurs while AUTO START/STOP timer is active, the timer setting is cancelled. As these models are equipped with an auto restart function, the air conditioner starts operating with timer cancelled at the same time that power is restored.
- If the unit has been off with the remote controller before power failure, the auto restart function does not work as the power button of the remote controller is off.
- To prevent breaker off due to the rush of starting current, systematize other home appliances not to turn on at the same time.

4-6 PIPE FORMING

- Place the drain hose below the refrigerant piping.
- Make sure that the drain hose is not heaved or snaked.
- Do not pull the hose to apply the tape.
- When the drain hose passes the room, be sure to wrap insulation material (obtainable at a store) around it.
- Wrap the felt tape ⑦ around the pipe and the drain hose, then put the pipe in the back space of the indoor unit.

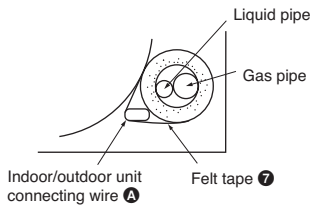

FOR REAR, RIGHT OR DOWNWARD PIPING

- Pipe arrangement
Put the refrigerant piping and the drain hose together, then apply piping tape ⑥ to them.

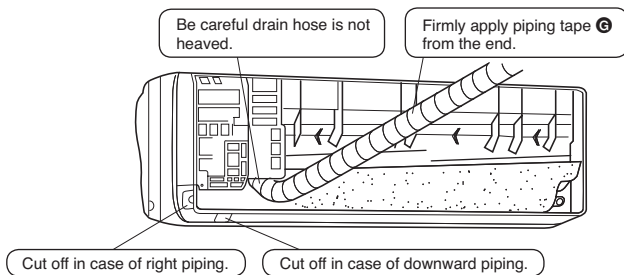

- Insert the piping and the drain hose into the wall hole sleeve ③, and hook the upper part of the indoor unit on the installation plate ①.
- Check if the indoor unit is hooked securely on the installation plate ① by moving the unit to left and right.
- Thrust the lower part of the indoor unit into the installation plate ①.

FOR LEFT OR LEFT-REAR PIPING

- Pipe arrangement
Put the refrigerant piping and the drain hose together, then apply felt tape ⑦ to them.

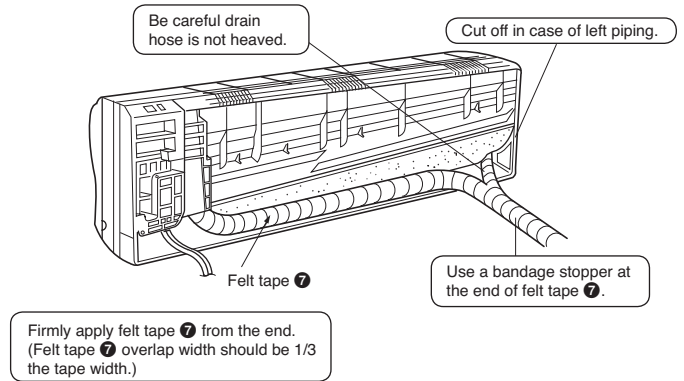

REATTACHING DRAIN HOSE

Be sure to reattach the drain hose and the drain cap in case of left or left-rear piping. Otherwise, it could cause drops of water to drip down from the drain hose.

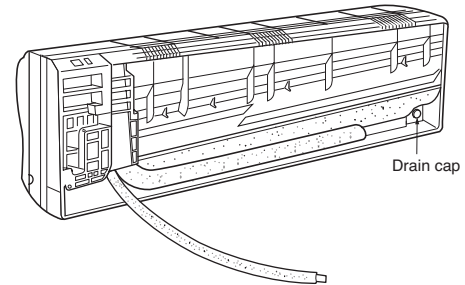

① Pull out the drain cap at the rear right of the indoor unit.

Hold the convex section at the end and pull the drain cap.

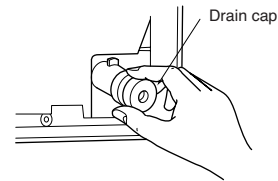

② Pull out the drain hose at the rear left of the indoor unit.

Hold the claw marked by the arrow and pull out the drain hose forward.

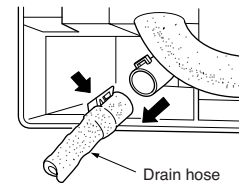

③ Put the drain cap into the section to which the drain hose is to be attached at the rear of the indoor unit.

Insert the screwdriver, etc. (not sharp-edged tool) into the hole at the end of the cap and insert the cap fully into the drain pan.

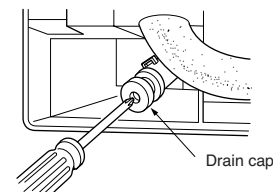

4 Insert the drain hose into the section to which the drain hose is to be attached at the rear right of the indoor unit.

Insert the drain hose fully into the drain pan. Check if the hose is hooked securely to the projection of its inserting part at the drain pan.

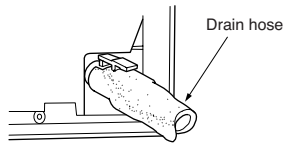

INDOOR UNIT INSTALLATION

- Insert the drain hose into the wall hole sleeve (C), and hook the upper part of indoor unit on the installation plate (1). Then, move the unit to the very edge of the left side for putting the piping easily in the back space of the indoor unit. After that, cut the part of packing material (spacer assembly) to hook it on the back rib and lift the indoor unit as shown in the figure below.

Cut part of packing material (spacer assembly) to hook it on the back rib.

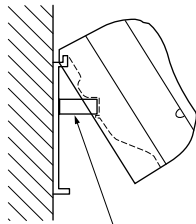
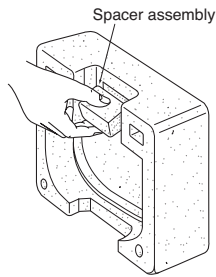

Securely attach the spacer assembly in the concave part of the rib, taking care its direction is correct as shown in the figure right.

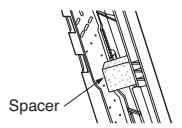

- Connect the refrigerant piping with the extension pipe (B).
- Thrust the lower part of the indoor unit into the installation plate (1).

4-7 DRAIN PIPING

- If the extension drain hose has to pass through a room, be sure to wrap it with commercially sold insulation.
- The drain hose should point downward for easy drain flow. (Fig. 1)
- Do not make drain piping as shown in Fig. 2 to 5.

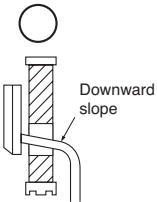

(Fig. 1)

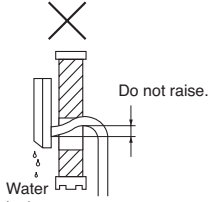

(Fig. 2)

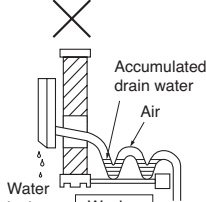

(Fig. 3)

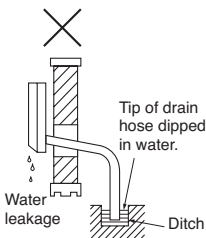

(Fig. 4)

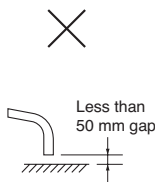

(Fig. 5)

- If the drain hose provided with the indoor unit is too short, connect it with drain hose (1) that should be provided at your site. (Fig. 6)
- When connecting the drain hose to the hard vinyl chloride pipe, be sure to insert it securely into the pipe. (Fig. 7)

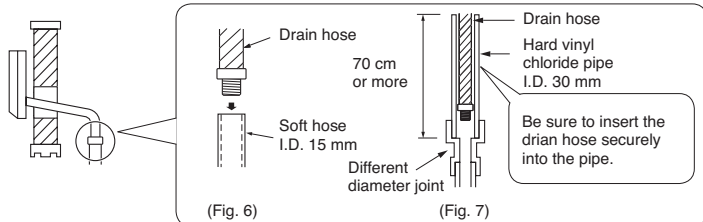

5. OUTDOOR UNIT INSTALLATION

INDOOR/OUTDOOR UNIT CONNECTING WIRE CONNECTION AND OUTDOOR POWER SUPPLY CORD CONNECTION

- Connect the indoor/outdoor unit connecting wire (A) from the indoor unit correctly on the terminal block.
- For future servicing, give extra length to connecting wire.

Rated Voltage	Breaker capacity	<ul style="list-style-type: none"> • Connect to the supply terminals and leave a contact separation of at least 3 mm at each pole to disconnect the source power pole. (When the power switch is shut off, it must disconnect all poles.) • Max. Permissible System Impedance 0.17(Ω) for 71/80 types
230 V	25 A	

- Peel off both ends of connecting wire (extension wire). When too long, or connected by cutting off the middle, peel off power supply wire to the size as shown in the right.
- Be careful not to contact connecting wire with piping.
- Make earth wire a little longer than the others. (more than 35 mm)

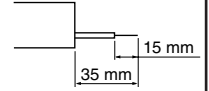

- For the power supply cord and the indoor/outdoor unit connecting wires, be sure to use the ones in compliance with the standards.
- Be sure to push the core until it is hidden and pull each cable to make sure that it is not pulled up incomplete insertion may cause a risk of burning the terminal blocks.

Power supply cord Specification	3-core 2.5 mm ² or more, in conformity with Design 60245 IEC 57.	10 m or less
Indoor and Outdoor connecting wire Specification	Cable 2-core 1.0 mm ² , in conformity with Design 60245 IEC 57.	

WARNING

- A means for disconnection of the supply with an isolation switch, or similar device, in all active conductors shall be incorporated in the fixed wiring.
- Never cut the power cord and connect it to other wires. It may cause a fire.

MS Type and MSH Type

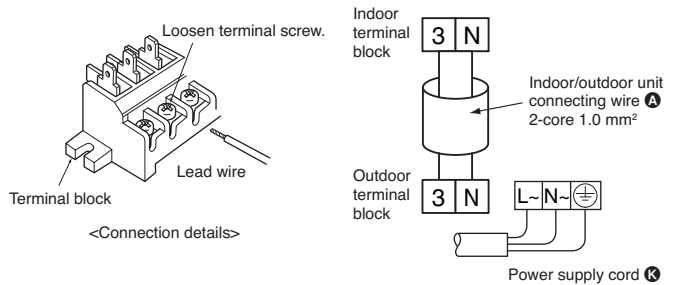

CAUTION

- Use care not to make mis-wiring.
- Firmly tighten the terminal screws to prevent them from loosening.
- After tightening, pull the wires lightly to confirm that they do not move.
- If the connecting wire is incorrectly connected to the terminal block, the unit does not operate normally.

Be sure to fix the indoor/outdoor unit connecting wire **A** and power supply cord **K** using this cord clamp.

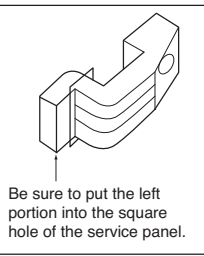

Be sure to put the left portion into the square hole of the service panel.

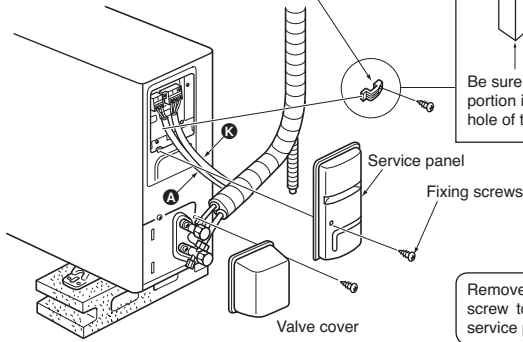

Remove the fixing screw to open the service panel.

⚠ WARNING

Be sure to attach the service panel of the outdoor unit securely. If it is not attached correctly, it could result in a fire or an electric shock due to dust, water, etc.

6. INDOOR/OUTDOOR UNIT CONNECTION FINISHING AND TEST RUN

INSTALLATION INFORMATION FOR THE AIR CONDITIONER WITH R410A REFRIGERANT

- This room air conditioner adopts an HFC refrigerant (R410A) which will never destroy the ozone layer.
- Pay particular attention to the following points, though the basic installation procedure is same as that for R22 air conditioners.
 - As R410A has a working pressure approx. 1.6 times as high as that of R22, some special tools and piping parts / materials are required. (Refer to the table below.)
 - Take sufficient care not to allow water and other contaminations to enter the R410A refrigerant during storage and installation, since it is more susceptible to contaminations than R22.
 - For refrigerant piping, use clean, pressure-proof parts / materials specifically designed for R410A. (Refer to 2. Refrigerant piping.)
 - Composition change may occur in R410A since it is a mixed refrigerant. When charging, charge liquid refrigerant to prevent composition change.

6-1 Tools dedicated for the air conditioner with R410A refrigerant

The following tools are required for R410A refrigerant. Some R22 tools can be substituted for R410A tools.

The diameter of the service port on the stop valve in outdoor unit has been changed to prevent any other refrigerant being charged into the unit. (Cap size has been changed from 7/16 UNF with 20 threads to 1/2 UNF with 20 threads.)

R410A tools	Can R22 tools be used?	Description
Gauge manifold	No	R410A has high pressures beyond the measurement range of existing gauges. Port diameters have been changed to prevent any other refrigerant from being charged into the unit.
Charge hose	No	Hose material and cap size have been changed to improve the pressure resistance.
Gas leak detector	No	Dedicated for HFC refrigerant.
	Yes	1/4
Torque wrench	No	1/2 and 5/8
	Yes	Clamp bar hole has been enlarged to reinforce the spring strength in the tool.
Flare gauge	New	Provided for flaring work (to be used with R22 flare tool).
Vacuum pump adaptor	New	Provided to prevent the back flow of oil. This adaptor enables you to use existing vacuum pumps.
Electronic scale for refrigerant charging	New	It is difficult to measure R410A with a charging cylinder because the refrigerant bubbles due to high pressure and high-speed vaporization.

No: Not substitutable for R410A Yes: Substitutable for R410A

6-2 FLARING WORK

- Main cause of gas leakage is defect in flaring work. Carry out correct flaring work in the following procedure.

1 Pipe cutting

- Cut the copper pipe correctly with pipe cutter.

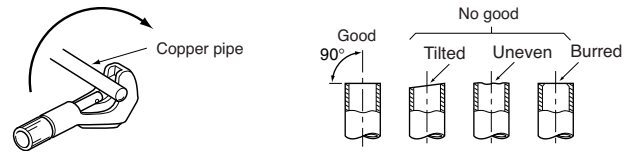

2 Burrs removal

- Completely remove all burrs from the cut cross section of pipe.
- Put the end of the copper pipe to downward direction as you remove burrs in order to avoid to let burrs drop in the piping.

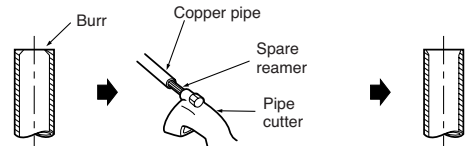

3 Putting nut on

- Remove flare nuts attached to indoor and outdoor units, then put them on pipe having completed burr removal. (not possible to put them on after flaring work)
- Flare nut for R410A pipe differs from R22 pipe. Refer to the following table for detail.

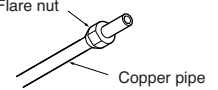

mm	Inch	R410A	R22
ø6.35	1/4	17	17
ø9.52	3/8	22	22
ø15.88	5/8	29	27

4 Flaring work

- Carry out flaring work using flaring tool as shown below.

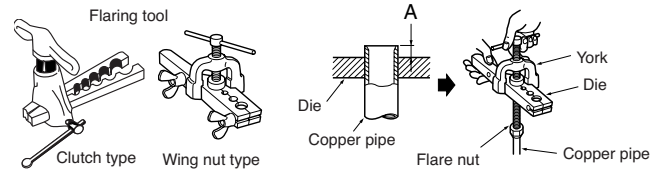

Outside diameter	Flare tool for R410A clutch type	A (mm)	
		Clutch type	Wing nut type
ø6.35 mm	0 to 0.5	1.0 to 1.5	1.5 to 2.0
ø9.52 mm	0 to 0.5	1.0 to 1.5	1.5 to 2.0
ø15.88 mm	0 to 0.5	1.0 to 1.5	2.0 to 2.5

- Firmly hold copper pipe in a die in the dimension shown in the table above.

5 Check

- Compare the flared work with figure below.
- If flare is noted to be defective, cut off the flared section and do flaring work again.

Smooth all around Inside is shining without any scratches.

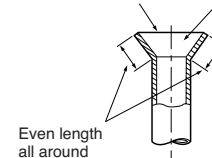

6-3 PIPE CONNECTION

Note:

Fasten a flare nut with a torque wrench as specified in the table below. When fastened too tight, a flare nut may be broken after a long period and cause a leakage of refrigerant.

① Indoor unit connection

Connect both liquid and gas pipings to indoor unit.

- Apply a thin coat of refrigeration oil **①** on the seat surface of pipe.
- For connection first align the center, then tighten the first 3 to 4 turns of flare nut.
- Use tightening torque table below as a guideline for indoor unit side union joint section, and tighten using two wrenches. Excessive tightening damages the flare section.

Pipe diameter	Tightening torque	
	N·m	kgf·cm
6.35	13.7 to 17.7	140 to 180
9.52	34.3 to 41.2	350 to 420
15.88	73.5 to 78.4	750 to 800

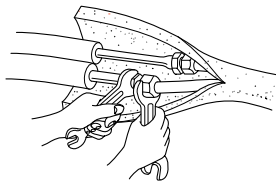

② Outdoor unit connection

Connect pipes to stop valve pipe joint of the outdoor unit in the same manner applied for indoor unit.

- For tightening, use a torque wrench or spanner and use the same tightening torque applied for indoor unit.

INSULATION AND TAPING

- Cover piping joints with pipe cover.
- For outdoor unit side, surely insulate every piping including valves.
- Using piping tape ⑥, apply taping starting from the entry of outdoor unit.
- Stop the end of piping tape ⑥ with tape (with adhesive agent attached).
- When piping have to be arranged through above ceiling, closet or where the temperature and humidity are high, wind additional commercially sold insulation for prevention of condensation.

6-4 PURGING PROCEDURES-LEAK TEST

PURGING PROCEDURES

Connect the refrigerant pipes (both liquid pipe and the gas pipe) between the indoor and the outdoor unit.

Remove the service port cap of the stop valve on the side of the outdoor unit gas pipe. (The stop valve will not work in its initial state fresh out of the factory (totally closed with cap on).)

Connect the gauge manifold valve and the vacuum pump to the service port of the stop valve on the gas pipe side of the outdoor unit.

Run the vacuum pump. (Vacuumize for more than 15 minutes.)

Check the vacuum with the gauge manifold valve, then close the gauge manifold valve, and stop the vacuum pump.

Leave as it is for one or two minutes. Make sure the pointer gauge manifold valve remains in the same position. Confirm that the pressure gauge shows -0.101 Mpa [Gauge] (-760 mmHg).

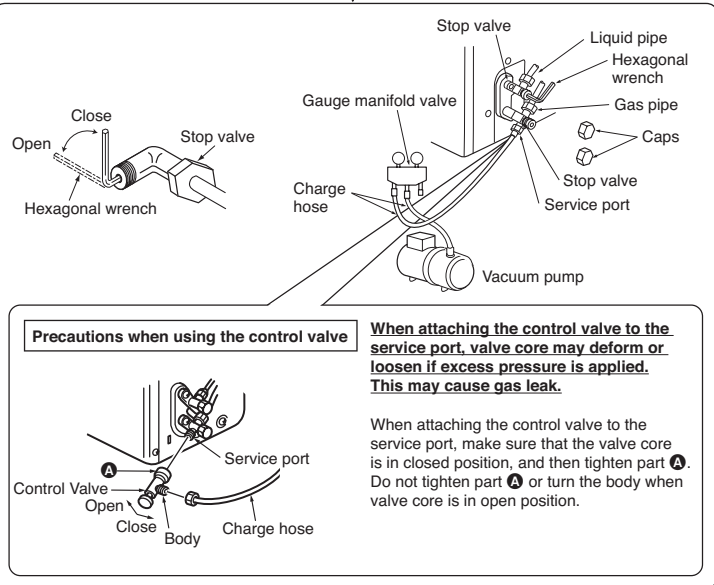

Remove the gauge manifold valve quickly from the service port of the stop valve.

After refrigerant pipes are connected and evacuated, fully open all stop valves on both sides of gas pipe and liquid pipe. Operating without fully opening lowers the performance and this causes trouble.

Pipe length up to 7 m
No gas charge is needed.

Pipe length exceeding 7 m
Charge the prescribed amount of gas. (refer to 3)

Tighten the cap to the service port to obtain the initial status.

Retighten the cap.

Leak test

	Tightening torque	
	N·m	kgf·cm
Cap for service port	13.7 to 17.7	140 to 180
Cap for stop valve	19.6 to 29.4	200 to 300

6-5 TEST RUN

MS Type

- Before performing the test run, recheck for any wrong wiring. Wrong wiring prevents normal operation or results in blown fuse disabling operation.
- The test run can be started by pressing EMERGENCY OPERATION switch. When the EMERGENCY OPERATION switch is once pressed, the unit will start the test run (continuous operation) for 30 minutes. A thermostat does not work during this time. After 30 minutes the unit will start the EMERGENCY OPERATION at a fixed temperature setting of 24 °C in COOL MODE.
- Perform test run in the following procedure.

PROCEDURE

- Press the EMERGENCY OPERATION switch.
- Press it once, and after test run for 30 minutes the EMERGENCY COOL MODE starts.
- Press it once more, and the operation stops. (The operation mode alternates between ① and ② every time the EMERGENCY OPERATION switch is pressed.)

	Mode	Operation Indicator lamp	
①	COOL	● (Light)	○ (Off)
②	STOP	○ (Off)	○ (Off)

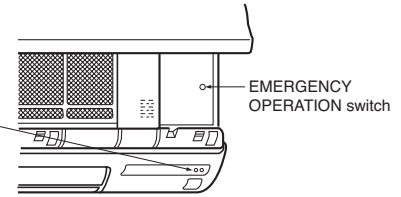

MSH Type

- Before performing the test run, recheck any wrong wiring. Wrong wiring prevents normal operation or results in blown fuse disabling operation.
- The test run can be started by pressing EMERGENCY OPERATION switch. When the EMERGENCY OPERATION switch is once pressed, the unit will start the test run (continuous operation) for 30 minutes. A thermostat does not work during this time. After 30 minutes the unit will start the EMERGENCY OPERATION at a fixed temperature setting of 24°C in COOL MODE or HEAT MODE.
- Perform test run in the following procedure.

PROCEDURE

- Press the EMERGENCY OPERATION switch.
- Press it once, and after test run for 30 minutes the EMERGENCY COOL MODE starts.

If the left side lamp of the operation indicator blinks every 0.5 seconds, inspect the indoor/outdoor unit connecting wire A for mis-wiring.

- Press it once more, and the EMERGENCY HEAT MODE starts.
- Press it once more, and the operation stops. (The operation mode changes in order of ① ~ ③ every time the EMERGENCY OPERATION switch is pressed.)

	Mode	Operation Indicator lamp	
①	COOL	● (Light)	○ (Off)
②	HEAT	○ (Off)	● (Light)
③	STOP	○ (Off)	○ (Off)

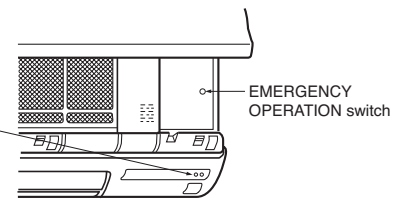

- In starting the heating operation, indoor unit fan may not operate to prevent blowing cool air. Please wait for a few minutes until the temperature of heat exchanger rises and warm air blows out.

MS Type and MSH Type

Checking the remote (infrared) signal reception

Press the ON/OFF button on the remote controller and check that an electronic sound is heard from the indoor unit. Press the ON/OFF button again to turn the air conditioner off.

If the indoor unit is operated with the remote controller, both the test run and the emergency operation are released by commands from the remote controller.

- Once the compressor stops, the restart preventive device operates so the compressor will not operate for three minutes to protect the air conditioner.

6-6 EXPLANATION TO THE CUSTOMER

- Using the OPERATING INSTRUCTIONS, explain the following to the customer, how to control temperature, how to remove the air filters, how to remove or put the remote controller in the remote controller holder, how to clean, precautions for operation, etc.
- Recommend the customer to read the OPERATING INSTRUCTIONS carefully.

7. FOR MOVEMENT AND MAINTENANCE

7-1 REMOVING AND REINSTALLING THE FRONT PANEL

FRONT PANEL REMOVAL

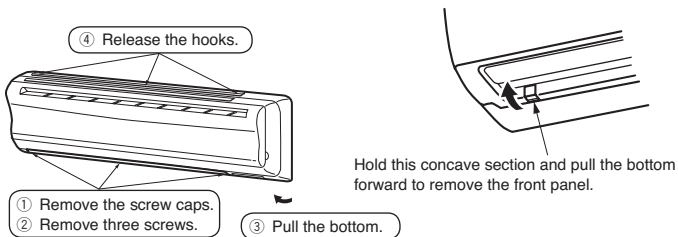

FRONT PANEL REINSTALLATION

Note:

Do not open the front panel up beyond the level position.

The panel may come off in order to prevent it from being damaged.

- Set the horizontal vane to the position as below before reinstalling the front panel.

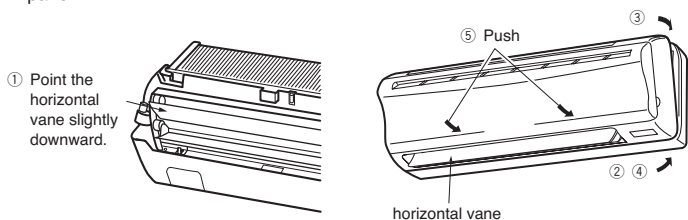

7-2 REMOVING THE INDOOR UNIT

Remove the bottom of the indoor unit from the installation plate.

- Remove the front panel. (See FRONT PANEL REMOVAL shown above.)
- Insert flat screwdrivers into the square holes at the left and right bottom of the indoor unit and push them up; the bottom of the indoor unit goes down and the hooks are released.

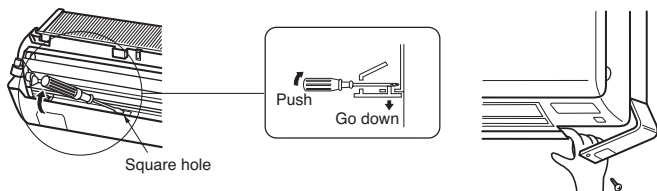

7-3 GAS CHARGE

- Connect gas cylinder to the service port of stop valve (3-way).
- Execute air purge of the pipe (or hose) coming from refrigerant gas cylinder.
- Replenish specified amount of the refrigerant, while operating the air conditioner for cooling.

Note:

In case of adding refrigerant, comply with the quantity specified for the refrigerating cycle.

CAUTION

- Do not discharge the refrigerant into the atmosphere.**
Take care not to discharge refrigerant into the atmosphere during installation, reinstallation, or repairs to the refrigerant circuit.
- When charging the refrigerant system with additional refrigerant, be sure to use liquid refrigerant.**
Adding gas refrigerant may change the composition of the refrigerant in the system and affect normal operation of the air conditioner. Also, charge the system slowly, otherwise the compressor will be locked.

To maintain the high pressure of the gas cylinder, warm the gas cylinder with warm water (under 40°C) during cold season. But never use naked fire or steam.

