

Air-Conditioners

SEZ-KD25,KD35,KD50,KD60,KD71VA

INSTALLATION MANUAL

For safe and correct use, please read this installation manual thoroughly before installing the air-conditioner unit.

FOR INSTALLER

INSTALLATIONSHANDBUCH

Zum sicheren und ordnungsgemäßen Gebrauch der Klimaanlage das Installationshandbuch gründlich durchlesen.

FÜR INSTALLATEURE

MANUEL D'INSTALLATION

Veillez lire le manuel d'installation en entier avant d'installer ce climatiseur pour éviter tout accident et vous assurer d'une utilisation correcte.

POUR L'INSTALLATEUR

MANUAL DE INSTALACIÓN

Para un uso seguro y correcto, lea detalladamente este manual de instalación antes de montar la unidad de aire acondicionado.

PARA EL INSTALADOR

MANUALE DI INSTALLAZIONE

Per un uso sicuro e corretto, leggere attentamente questo manuale di installazione prima di installare il condizionatore d'aria.

PER L'INSTALLATORE

INSTALLATIEHANDLEIDING

Voor een veilig en juist gebruik moet u deze installatiehandleiding grondig doorlezen voordat u de airconditioner installeert.

VOOR DE INSTALLATEUR

INSTALLATIONS MANUAL

Läs denna installationsmanual noga för säkert och korrekt bruk innan luftkonditioneringen installeras.

FÖR INSTALLATÖREN

INSTALLATIONS MANUAL

Læs venligst denne installationsmanual grundigt, før De installerer aircondition anlægget, af hensyn til sikker og korrekt anvendelse.

TIL INSTALLATØREN

MANUAL DE INSTALAÇÃO

Para segurança e utilização correctas, leia atentamente este manual de instalação antes de instalar a unidade de ar condicionado.

PARA O INSTALADOR

ΕΓΧΕΙΡΙΔΙΟ ΟΔΗΓΙΩΝ ΕΓΚΑΤΑΣΤΑΣΗΣ

ΓΙΑ ΑΥΤΟΝ ΠΟΥ ΚΑΝΕΙ ΤΗΝ ΕΓΚΑΤΑΣΤΑΣΗ

Για ασφάλεια και σωστή χρήση, παρακαλείστε διαβάσετε προσεχτικά αυτό το εγχειρίδιο εγκατάστασης πριν αρχίσετε την εγκατάσταση της μονάδας κλιματισμού.

РУКОВОДСТВО ПО УСТАНОВКЕ

ДЛЯ УСТАНОВИТЕЛЯ

Для осторожного и правильного использования прибора необходимо тщательно ознакомиться с данным руководством по установке до выполнения установки кондиционера.

MONTAJ ELKİTABI

MONTÖR İÇİN

Emniyetli ve doğru biçimde nasıl kullanılacağını öğrenmek için lütfen klima cihazını monte etmeden önce bu elkitabını dikkatle okuyunuz.

安裝說明書

安裝人員適用

在安裝冷氣機之前，請先詳閱此安裝說明書，以便安全正確地使用。

English**Deutsch****Français****Español****Italiano****Nederlands****Svenska****Dansk****Português****Ελληνικά****Русский****Türkçe****繁體中文**

3

3.1

[Fig. 3-1]

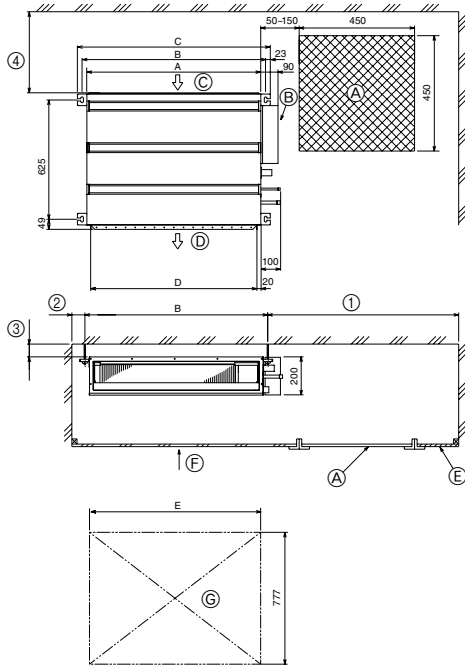

- Ⓐ Access door
- Ⓑ Electrical parts box
- Ⓒ Air inlet
- Ⓓ Air outlet
- Ⓔ Ceiling surface
- Ⓕ Service space (viewed from the side)
- Ⓖ Service space (viewed from the direction of arrow)
- ① 600 mm or more
- ② 100 mm or more
- ③ 10 mm or more
- ④ 300 mm or more

Model	A	B	C	D	E
SEZ-KD25	700	752	798	660	800
SEZ-KD35, 50	900	952	998	860	1000
SEZ-KD60, 71	1100	1152	1198	1060	1200

(mm)

3.3

[Fig. 3-2]

■ SUZ-KA25VA

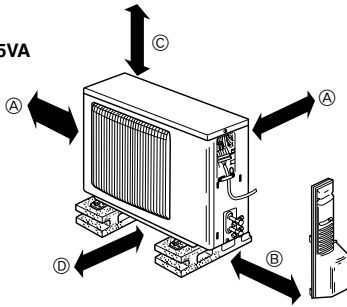

- Ⓐ 100 mm or more
- Ⓑ 350 mm or more
- Ⓒ Basically open 100 mm or more without only obstruction in front and on both sides of the unit.
- Ⓓ 200 mm or more (Open two sides of left, right, or rear side.)

4

[Fig. 4-1]

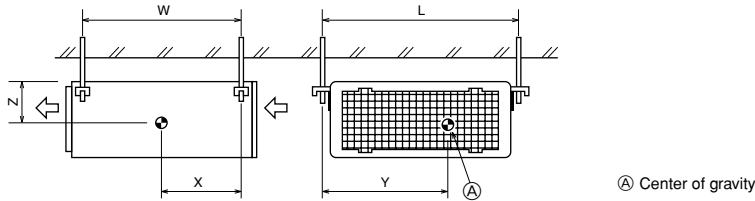

Ⓐ Center of gravity

5

5.1

[Fig. 5-1]

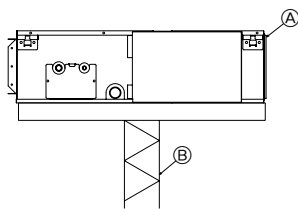

- Ⓐ Unit body
- Ⓑ Lifting machine

[Fig. 5-2]

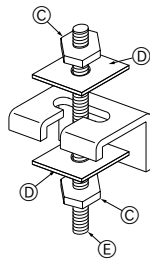

- Ⓒ Nuts (field supply)
- Ⓓ Washers (accessory)
- Ⓔ M10 hanging bolt (field supply)

5.2

[Fig. 5-3]

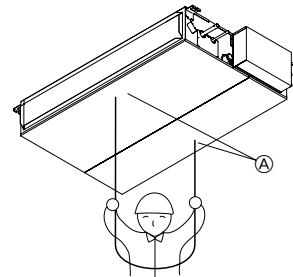

Ⓐ Indoor unit's bottom surface

6.1

[Fig. 6-1]

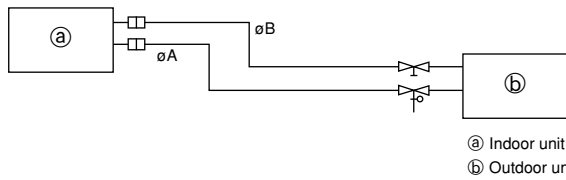

Model	A	B
SEZ-KD25, 35	9.52	6.35
SEZ-KD50	12.7	6.35
SEZ-KD60	15.88	6.35
SEZ-KD71	15.88	9.52

Ⓐ Indoor unit
Ⓑ Outdoor unit

6.2

[Fig. 6-3]

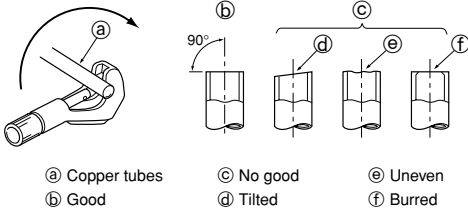

Ⓐ Copper tubes
Ⓑ Good
Ⓒ No good
Ⓓ Tilted
Ⓔ Uneven
Ⓕ Burred

[Fig. 6-4]

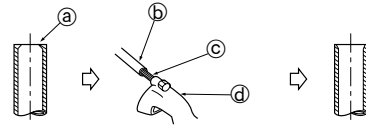

Ⓐ Burr
Ⓑ Copper tube/pipe
Ⓒ Spare reamer
Ⓓ Pipe cutter

[Fig. 6-5]

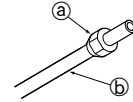

Ⓐ Flare nut
Ⓑ Copper tube

[Fig. 6-6]

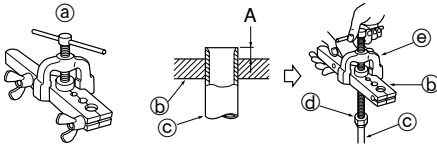

Ⓐ Flaring tool
Ⓑ Die
Ⓒ Copper tube
Ⓓ Flare nut
Ⓔ Yoke

[Fig. 6-7]

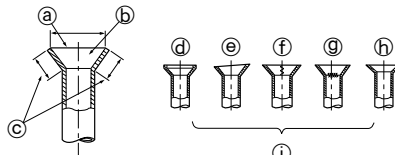

Ⓐ Smooth all around
Ⓑ Inside is shining without any scratches
Ⓒ Even length all around
Ⓓ Too much
Ⓔ Tilted
Ⓕ Scratch on flared plane
Ⓖ Cracked
Ⓗ Uneven
Ⓘ Bad examples

6.3

[Fig. 6-8]

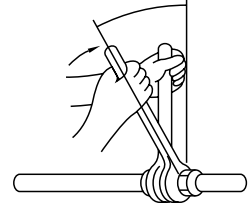

[Fig. 6-9]

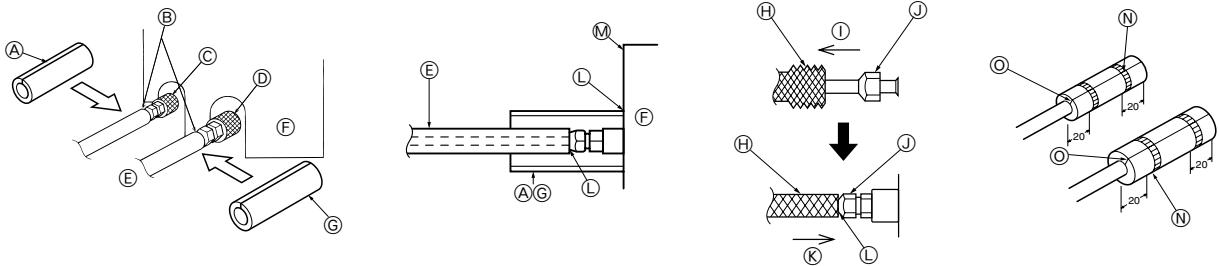

Ⓐ Pipe cover (small) (accessory)
Ⓑ Caution:
Pull out the thermal insulation on the refrigerant piping at the site, insert the flare nut to flare the end, and replace the insulation in its original position.
Take care to ensure that condensation does not form on exposed copper piping.
Ⓒ Liquid end of refrigerant piping
Ⓓ Gas end of refrigerant piping
Ⓔ Site refrigerant piping
Ⓕ Main body
Ⓖ Pipe cover (large) (accessory)
Ⓗ Thermal insulation (field supply)
Ⓘ Pull
Ⓙ Flare nut
Ⓚ Return to original position
Ⓛ Ensure that there is no gap here
Ⓜ Plate on main body
Ⓝ Band (accessory)
Ⓞ Ensure that there is no gap here. Place join upwards.

6.5

[Fig. 6-10]

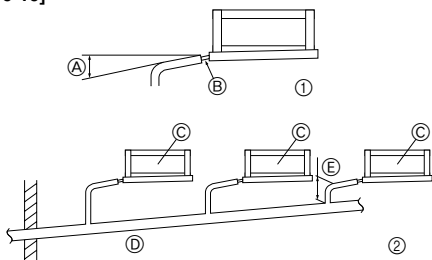

Ⓐ Downward slope 1/100 or more
Ⓑ Connection dia. R1 external thread
Ⓒ Indoor unit
Ⓓ Collective piping
Ⓔ Maximize this length to approx. 10 cm

[Fig. 6-11]

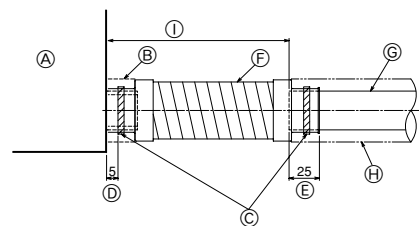

Ⓐ Indoor unit
Ⓑ Pipe cover (short) (accessory)
Ⓒ Tie band (accessory)
Ⓓ Band fixing part
Ⓔ Insertion margin
Ⓕ Drain hose (accessory)
Ⓖ Drain pipe (O.D. ø32 PVC TUBE, field supply)
Ⓗ Insulating material (field supply)
Ⓘ Max. 145 ± 5 mm

[Fig. 7-1]

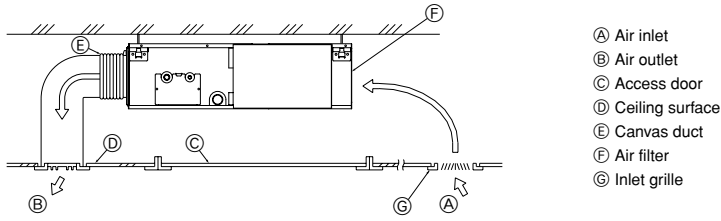

- Ⓐ Air inlet
- Ⓑ Air outlet
- Ⓒ Access door
- Ⓓ Ceiling surface
- Ⓔ Canvas duct
- Ⓕ Air filter
- Ⓖ Inlet grille

8.1

[Fig. 8-1]

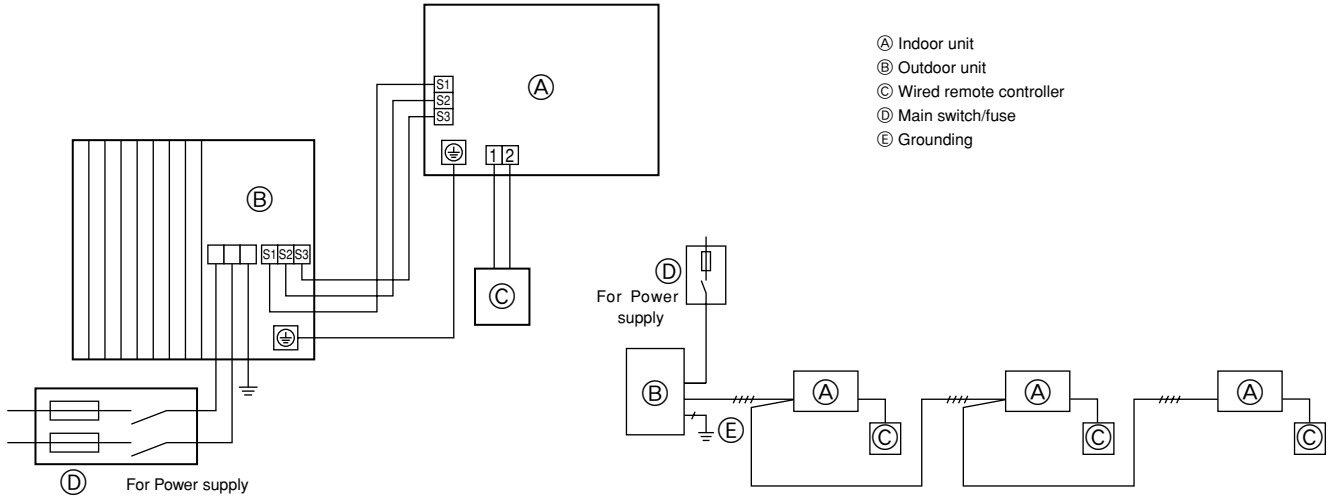

- Ⓐ Indoor unit
- Ⓑ Outdoor unit
- Ⓒ Wired remote controller
- Ⓓ Main switch/fuse
- Ⓔ Grounding

8.2

[Fig. 8-2-1]

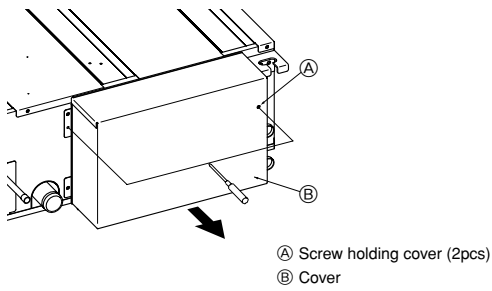

[Fig. 8-2-2]

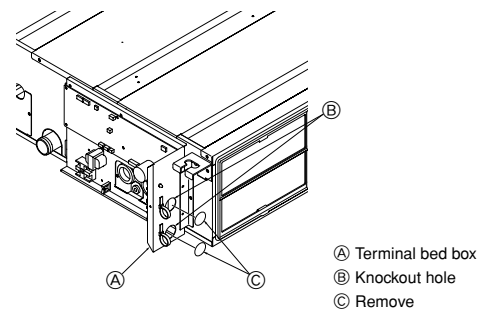

[Fig. 8-2-3]

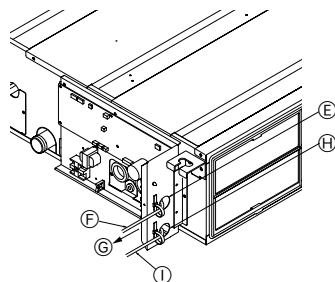

[Fig. 8-2-4]

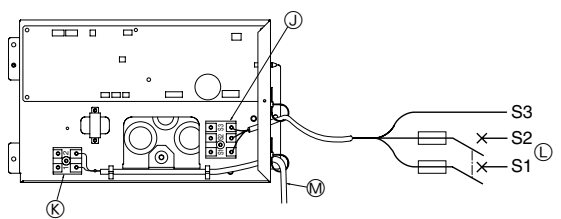

- Ⓔ Use PG bushing to keep the weight of the cable and external force from being applied to the power supply terminal connector. Use a cable tie to secure the cable.
- Ⓕ Power source wiring
- Ⓖ Tensile force
- Ⓖ Use ordinary bushing
- Ⓖ Transmission wiring

- Ⓖ Terminal bed for power source and indoor transmission
- Ⓖ Terminal bed for remote controller
- Ⓖ To 1-phase power source
- Ⓖ Transmission line to the remote controller

[Fig. 8-3]

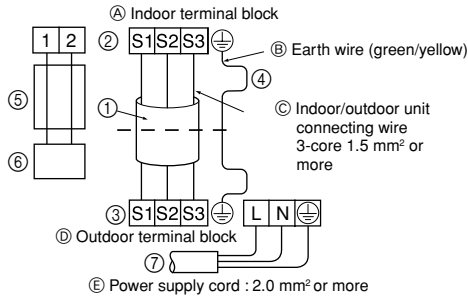

- ④ Indoor terminal block
- ⑤ Earth wire (green/yellow)
- ⑥ Indoor/outdoor unit connecting wire 3-core 1.5 mm² or more
- ⑦ Outdoor terminal block
- ⑧ Power supply cord : 2.0 mm² or more
- ⑨ Connecting cable
- ⑩ Cable 3-core 1.5 mm², in conformity with Design 245 IEC 57.
- ⑪ Indoor terminal block
- ⑫ Outdoor terminal block

- ⑬ Always install an earth wire (1-core 1.5 mm²) longer than other cables
- ⑭ Remote controller cable
Wire No × size (mm²) : Cable 2C × 0.3
This wire accessory of remote controller (wire length : 10m, non-polar. Max. 500m)
- ⑮ Wired remote controller
⑯ Power supply cord
Cable 3-core 2.0 mm² or more, in conformity with Design 245 IEC 57.

8.3

[Fig. 8-4]

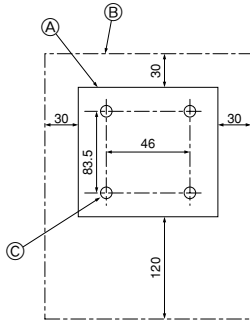

- ① Remote controller profile
- ② Required clearances surrounding the remote controller
- ③ Installation pitch

[Fig. 8-5]

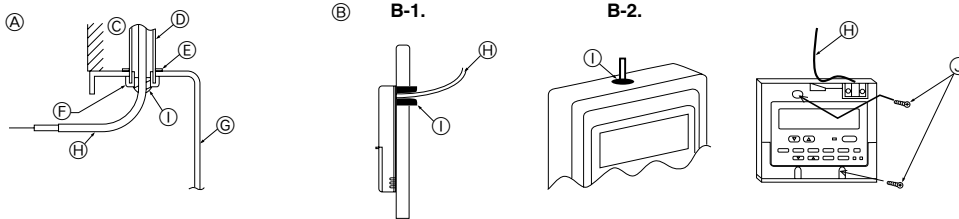

- ① For installation in the switch box:
- ② For direct installation on the wall select one of the following:
 - Prepare a hole through the wall to pass the remote controller cord (in order to run the remote controller cord from the back), then seal the hole with putty.
 - Run the remote controller cord through the cut-out upper case, then seal the cut-out notch with putty similarly as above.

- ③ Wall
- ④ Conduit
- ⑤ Lock nut
- ⑥ Bushing
- ⑦ Switch box
- ⑧ Remote controller cord
- ⑨ Seal with putty
- ⑩ Wood screw

[Fig. 8-6]

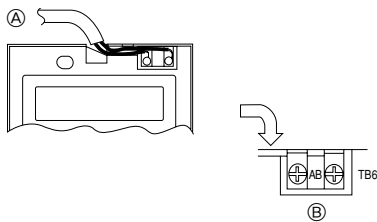

- ① To the terminal block on the indoor unit
- ② TB6 (No polarity)

8.4

[Fig. 8-7]

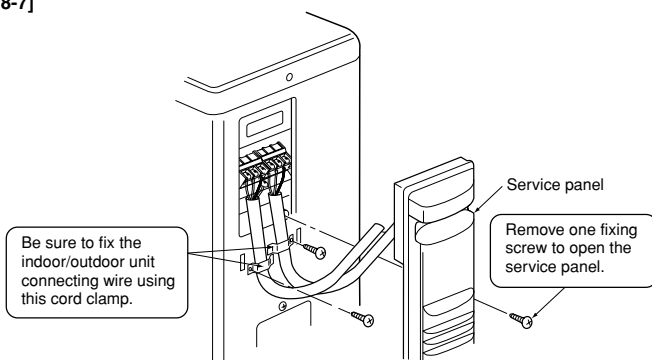

[Fig. 8-8]

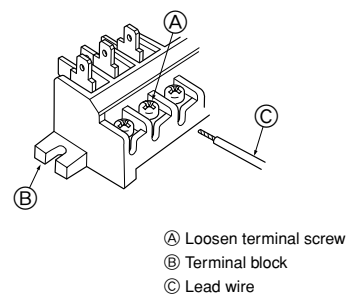

[Fig. 8-9]

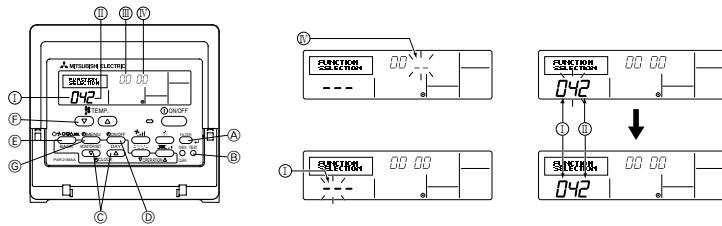

- ① Mode number
- ② Setting number
- ③ Refrigerant address
- ④ Unit number
- A Filter ↓ button (<Enter> button)
- B TEST button
- C Set Time button
- D Timer On/Off button (Set Day button)
- E Mode selection button
- F Set temperature button
- G Timer Menu button (Monitor/Set button)

[Fig. 9-1]

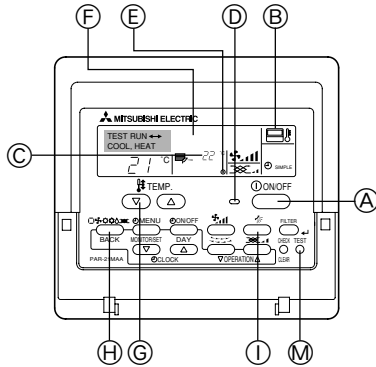

- A ON/OFF button
- B Test run display
- C Indoor temperature liquid line temperature display
- D ON/OFF lamp
- E Power display
- F Error code display
- G Test run remaining time display
- H Set temperature button
- I Mode selection button
- J Fan speed button
- K TEST button

[Fig. 9-2]

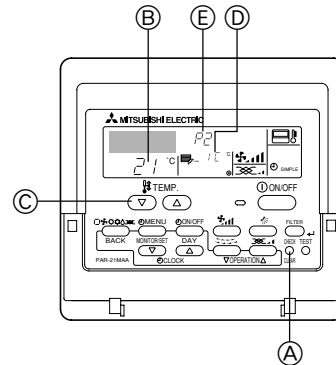

- A CHECK button
- B Refrigerant address
- C TEMP. button
- D IC: Indoor unit
- E Check code
- OC: Outdoor unit

[Fig. 10-1]

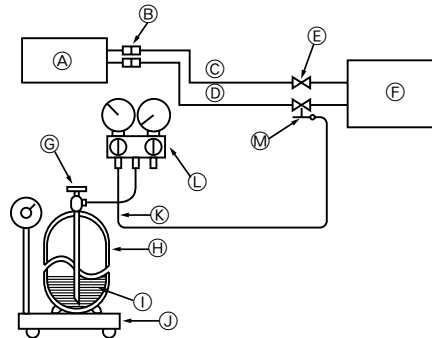

- A Indoor unit
- B Union
- C Liquid pipe
- D Gas pipe
- E Stop valve
- F Outdoor unit
- G Refrigerant gas cylinder operating valve
- H Refrigerant gas cylinder for R410A with siphon
- I Refrigerant (liquid)
- J Electronic scale for refrigerant charging
- K Charge hose (for R410A)
- L Gauge manifold valve (for R410A)
- M Service port

Contents

1. Safety precautions	7	9. Test run	13
2. Selecting the installation location	7	10. Maintenance	14
3. Selecting an installation site & Accessories	8		
4. Fixing hanging bolts	8		
5. Installing the unit	8		
6. Refrigerant piping work	9		
7. Duct work	11		
8. Electrical work	11		

This Installation Manual describes only for the indoor unit and the connected outdoor unit of SUZ series.
If the connected outdoor unit is MXZ series, refer to the Installation Manual for MXZ series.

1. Safety precautions

- Please report to or take consent by the supply authority before connection to the system.
- Be sure to read “The following should always be observed for safety” before installing the air conditioner.
- Be sure to observe the cautions specified here as they include important items related to safety.
- The indications and meanings are as follows.

⚠ Warning:

Could lead to death, serious injury, etc.

⚠ Caution:

Could lead to serious injury in particular environments when operated incorrectly.

- After reading this manual, be sure to keep it together with the instruction manual in a handy place on the customer's site.

⚠ Warning:

- Do not install it by yourself (customer).

Incomplete installation could cause injury due to fire, electric shock, the unit falling or leakage of water. Consult the dealer from whom you purchased the unit or special installer.

- Install the unit securely in a place which can bear the weight of the unit. When installed in an insufficient strong place, the unit could fall causing injured.
- Use the specified wires to connect the indoor and outdoor units securely and attach the wires firmly to the terminal board connecting sections so the stress of the wires is not applied to the sections. Incomplete connecting and fixing could cause fire.
- Do not use intermediate connection of the power cord or the extension cord and do not connect many devices to one AC outlet. It could cause a fire or an electric shock due to defective contact, defective insulation, exceeding the permissible current, etc.
- Check that the refrigerant gas does not leak after installation has completed.

⚠ Caution:

- Perform grounding.

Do not connect the ground wire to a gas pipe, water pipe arrester or telephone ground wire. Defective grounding could cause an electric shock.

- Do not install the unit in a place where an inflammable gas leaks. If gas leaks and accumulates in the area surrounding the unit, it could cause an explosion.

- Install a ground leakage breaker depending on the installation place (where it is humid). If a ground leakage breaker is not installed, it could cause an electric shock.

2. Selecting the installation location

2.1. Indoor unit

- Where airflow is not blocked.
- Where cool air spreads over the entire room.
- Where it is not exposed to direct sunshine.
- At a distance 1 m or more away from your TV and radio (to prevent picture from being distorted or noise from being generated).
- In a place as far away as possible from fluorescent and incandescent lights (so the infrared remote control can operate the air conditioner normally).

2.2. Outdoor unit

- Where it is not exposed to strong wind.
- Where airflow is good and dustless.
- Where it is not exposed to rain and direct sunshine.
- Where neighbours are not annoyed by operation sound or hot air.
- Where rigid wall or support is available to prevent the increase of operation sound or vibration.
- Where there is no risk of combustible gas leakage.
- When installing the unit at a high level, be sure to fix the unit legs.
- Where it is at least 3 m away from the antenna of TV set or radio. (Otherwise, images would be disturbed or noise would be generated.)

Symbols put on the unit

⊘ : Indicates an action that must be avoided.

ⓘ : Indicates that important instructions must be followed.

⚡ : Indicates a part which must be grounded.

⚠ : Indicates that caution should be taken with rotating parts.

⚡ : Indicates that the main switch must be turned off before servicing.

⚡ : Beware of electric shock.

⚠ : Beware of hot surface.

⚠ Warning:

Carefully read the labels affixed to the main unit.

- Perform the installation securely referring to the installation manual. Incomplete installation could cause a personal injury due to fire, electric shock, the unit falling or leakage of water.
- Perform electrical work according to the installation manual and be sure to use an exclusive circuit. If the capacity of the power circuit is insufficient or there is incomplete electrical work, it could result in a fire or an electric shock.
- Attach the electrical part cover to the indoor unit and the service panel to the outdoor unit securely. If the electrical part cover in the indoor unit and/or the service panel in the outdoor unit are not attached securely, it could result in a fire or an electric shock due to dust, water, etc.
- Be sure to use the part provided or specified parts for the installation work. The use of defective parts could cause an injury or leakage of water due to a fire, an electric shock, the unit falling, etc.
- Ventilate the room if refrigerant leaks during operation. If the refrigerant comes in contact with a flame, poisonous gases will be released.
- Perform the drainage/piping work securely according to the installation manual. If there is a defect in the drainage/piping work, water could drop from the unit and household goods could be wet and damaged.
- Fasten a flare nut with a torque wrench as specified in this manual. When fastened too tight, a flare nut may broken after a long period and cause a leakage of refrigerant.

- Where the air filter can be removed and replaced easily.

⚠ Warning:

Mount the indoor unit into a ceiling strong enough to withstand the weight of the unit.

- Install the unit horizontally.

⚠ Caution:

Avoid the following places for installation where air conditioner trouble is liable to occur.

- Where there is too much machine oil.
- Salty environment as seaside areas.
- Hot-spring areas.
- Where sulfide gas exists.
- Other special atmospheric areas.

3. Selecting an installation site & Accessories

- Select a site with sturdy fixed surface sufficiently durable against the weight of unit.
- Before installing unit, the routing to carry in unit to the installation site should be determined.
- Select a site where the unit is not affected by entering air.
- Select a site where the flow of supply and return air is not blocked.
- Select a site where refrigerant piping can easily be led to the outside.
- Select a site which allows the supply air to be distributed fully in room.
- Do not install unit at a site with oil splashing or steam in much quantity.
- Do not install unit at a site where combustible gas may generate, flow in, stagnate or leak.
- Do not install unit at a site where equipment generating high frequency waves (a high frequency wave welder for example) is provided.
- Do not install unit at a site where fire detector is located at the supply air side. (Fire detector may operate erroneously due to the heated air supplied during heating operation.)
- When special chemical product may scatter around such as site chemical plants and hospitals, full investigation is required before installing unit. (The plastic components may be damaged depending on the chemical product applied.)
- If the unit is run for long hours when the air above the ceiling is at high temperature/high humidity (dew point above 26 °C), due condensation may be produced in the indoor unit. When operating the units in this condition, add insulation material (10-20 mm) to the entire surface of the indoor unit to avoid due condensation.

3.1. Install the indoor unit on a ceiling strong enough to sustain its weight

[Fig. 3-1] (P.2)

- Ⓐ Access door
- Ⓑ Electrical parts box
- Ⓒ Air inlet
- Ⓓ Air outlet
- Ⓔ Ceiling surface
- Ⓕ Service space (viewed from the side)
- Ⓖ Service space (viewed from the direction of arrow)
- ① 600 mm or more
- ② 100 mm or more
- ③ 10 mm or more
- ④ 300 mm or more

* If the optional long-life filter is installed, the dimensions of the air conditioner increase.

Rear inlet: Depth increases by 30 mm (*1)
Bottom inlet: Height increases by 30 mm (*2)

⚠ Warning:

The unit must be securely installed on a structure that can sustain its weight. If the unit is mounted on an unstable structure, it may fall down causing injuries.

3.2. Securing installation and service space

- Select the optimum direction of supply airflow according to the configuration of the room and the installation position.
- As the piping and wiring are connected at the bottom and side surfaces, and the maintenance is made at the same surfaces, allow a proper space properly. For the efficient suspension work and safety, provide a space as much as possible.

3.3. Outdoor unit

Ventilation and service space

■ SUZ-KA25VA

[Fig. 3-2] (P.2)

- Ⓐ 100 mm or more
- Ⓑ 350 mm or more
- Ⓒ Basically open 100 mm or more without only obstruction in front and on both sides of the unit.
- Ⓓ 200 mm or more (Open two sides of left, right, or rear side.)

When the piping is to be attached to a wall containing metals (tin plated) or metal netting, use a chemically treated wooden piece 20 mm or thicker between the wall and the piping or wrap 7 to 8 turns of insulation vinyl tape around the piping.

Units should be installed by licensed contractor accordingly to local code requirement.

3.4. Indoor unit accessories

The unit is provided with the following accessories:

No.	Name	Quantity
①	Pipe cover (for refrigerant piping joint) Small diameter	1
②	Pipe cover (for refrigerant piping joint) Large diameter	1
③	Bands for temporary tightening of pipe cover and drain hose	6
④	Remote controller parts	1
⑤	Signal receiving unit cable	1
⑥	Washer	8
⑦	Drain hose	1
⑧	Pipe cover (for Drain hose) short	1

4. Fixing hanging bolts

4.1. Fixing hanging bolts

[Fig. 4-1] (P.2)

- Ⓐ Center of gravity

(Give site of suspension strong structure.)

Hanging structure

- Ceiling: The ceiling structure varies from building to one another. For detailed information, consult your construction company.

Center of gravity and Product Weight

Model name	W	L	X	Y	Z	Product Weight (kg)
SEZ-KD25	625	752	263	351	106	18
SEZ-KD35	625	952	286	448	104	21
SEZ-KD50	625	952	280	437	104	24
SEZ-KD60	625	1152	285	527	104	28
SEZ-KD71	625	1152	285	527	104	28

- If necessary, reinforce the hanging bolts with anti-quake supporting members as countermeasures against earthquakes.

* Use M10 for hanging bolts and anti-quake supporting members (field supply).

- ① Reinforcing the ceiling with additional members (edge beam, etc.) must be required to keep the ceiling at level and to prevent the ceiling from vibrations.
- ② Cut and remove the ceiling members.
- ③ Reinforce the ceiling members, and add other members for fixing the ceiling boards.

5. Installing the unit

5.1. Hanging the unit body

- ▶ Bring the indoor unit to an installation site as it is packed.
- ▶ To hang the indoor unit, use a lifting machine to lift and pass through the hanging bolts.

[Fig. 5-1] (P.2)

- Ⓐ Unit body
- Ⓑ Lifting machine

[Fig. 5-2] (P.2)

- Ⓒ Nuts (field supply)
- Ⓓ Washers (accessory)
- Ⓔ M10 hanging bolt (field supply)

5.2. Confirming the unit's position and fixing hanging bolts

- ▶ Use the gage supplied with the panel to confirm that the unit body and hanging bolts are positioned in place. If they are not positioned in place, it may result in dew drops due to wind leak. Be sure to check the positional relationship.
- ▶ Use a level to check that the surface indicated by Ⓐ is at level. Ensure that the hanging bolt nuts are tightened to fix the hanging bolts.
- ▶ To ensure that drain is discharged, be sure to hang the unit at level using a level.

[Fig. 5-3] (P.2)

- Ⓐ Indoor unit's bottom surface

⚠ Caution:

Be sure to install the unit body at level.

6. Refrigerant piping work

6.1. Refrigerant pipe

[Fig. 6-1] (P.3)

- Ⓐ Indoor unit
- Ⓑ Outdoor unit

Refer to the Instruction Manual that came with the outdoor unit for the restrictions on the height difference between units and for the amount of additional refrigerant charge.

Avoid the following places for installation where air conditioner trouble is liable to occur.

- Where there is too much oil such as for machine or cooking.
- Salty environment as seaside areas.
- Hot-spring areas.
- Where sulfide gas exists.
- Other special atmospheric areas.
- This unit has flared connections on both indoor and outdoor sides. (Fig. 6-1)
- Refrigerant pipes are used to connect the indoor and outdoor units as shown in the figure below.
- Insulate both refrigerant and drainage piping completely to prevent condensation.

Piping preparation

- Refrigerant pipes of 3, 5, 7, 10 and 15 m are available as optional items.

(1) Table below shows the specifications of pipes commercially available.

Model	Pipe	Outside diameter		Min wall thickness	Insulation thickness	Insulation material
		mm	inch			
SEZ-KD25	For liquid	6.35	1/4	0.8 mm	8 mm	Heat resisting foam plastic 0.045 specific gravity
	For gas	9.52	3/8	0.8 mm	8 mm	
SEZ-KD35	For liquid	6.35	1/4	0.8 mm	8 mm	
	For gas	9.52	3/8	0.8 mm	8 mm	
SEZ-KD50	For liquid	6.35	1/4	0.8 mm	8 mm	
	For gas	12.7	1/2	0.8 mm	8 mm	
SEZ-KD60	For liquid	6.35	1/4	0.8 mm	8 mm	
	For gas	15.88	5/8	1.0 mm	8 mm	
SEZ-KD71	For liquid	9.52	3/8	0.8 mm	8 mm	
	For gas	15.88	5/8	1.0 mm	8 mm	

(2) Ensure that the 2 refrigerant pipes are well insulated to prevent condensation.

(3) Refrigerant pipe bending radius must be 10 cm or more.

⚠ Caution:

Using careful insulation of specified thickness. Excessive thickness prevents storage behind the indoor unit and smaller thickness causes dew dripage.

6.2. Flaring work

- Main cause of gas leakage is defect in flaring work.
Carry out correct flaring work in the following procedure.

6.2.1. Pipe cutting

[Fig. 6-3] (P.3)

- Ⓐ Copper tubes
- Ⓑ Good
- Ⓒ No good
- Ⓓ Tilted
- Ⓔ Uneven
- Ⓕ Burred

- Using a pipe cutter cut the copper tube correctly.

6.2.2. Burrs removal

[Fig. 6-4] (P.3)

- Ⓐ Burr
- Ⓑ Copper tube/pipe
- Ⓒ Spare reamer
- Ⓓ Pipe cutter

- Completely remove all burrs from the cut cross section of pipe/tube.
- Put the end of the copper tube/pipe to downward direction as you remove burrs in order to avoid burrs drop in the tubing.

6.2.3. Putting nut on

[Fig. 6-5] (P.3)

- Ⓐ Flare nut
- Ⓑ Copper tube

- Remove flare nuts attached to indoor and outdoor unit, then put them on pipe/tube having completed burr removal.
(not possible to put them on after flaring work)

6.2.4. Flaring work

[Fig. 6-6] (P.3)

- Ⓐ Flaring tool
- Ⓑ Die
- Ⓒ Copper tube
- Ⓓ Flare nut
- Ⓔ Yoke

- Carry out flaring work using flaring tool as shown below.

Pipe diameter (mm)	Dimension	
	A (mm)	B ⁺⁰ _{-0.4} (mm)
	When the tool for R410A is used	
	Clutch type	
6.35	0 - 0.5	9.1
9.52	0 - 0.5	13.2
12.7	0 - 0.5	16.6
15.88	0 - 0.5	19.7

Firmly hold copper tube in a die in the dimension shown in the table at above.

6.2.5. Check

[Fig. 6-7] (P.3)

- Ⓐ Smooth all around
- Ⓑ Inside is shining without any scratches
- Ⓒ Even length all around
- Ⓓ Too much
- Ⓔ Tilted
- Ⓕ Scratch on flared plane
- Ⓖ Cracked
- Ⓗ Uneven
- Ⓘ Bad examples

- Compare the flared work with a figure in right side hand.
- If flare is noted to be defective, cut off the flared section and do flaring work again.

6.3. Pipe connection

[Fig. 6-8] (P.3)

- Apply a thin coat of refrigeration oil on the seat surface of pipe.
- For connection first align the center, then tighten the first 3 to 4 turns of flare nut.
- Use tightening torque table below as a guideline for indoor unit side union joint section, and tighten using two wrenches. Excessive tightening damages the flare section.

Copper pipe O.D. (mm)	Flare nut O.D. (mm)	Tightening torque (N·m)
ø6.35	17	14 - 18
ø9.52	22	34 - 42
ø12.7	26	49 - 61
ø15.88	29	68 - 82

⚠ Warning:

Be careful of flying flare nut! (Internally pressurized)

Remove the flare nut as follows:

1. Loosen the nut until you hear a hissing noise.
2. Do not remove the nut until the gas has been completely released (i.e., hissing noise stops).
3. Check that the gas has been completely released, and then remove the nut.

Outdoor unit connection

Connect pipes to stop valve pipe joint of the outdoor unit in the same manner applied for indoor unit.

- For tightening use a torque wrench or spanner, and use the same tightening torque applied for indoor unit.

6. Refrigerant piping work

Refrigerant pipe insulation

- After connecting refrigerant piping, insulate the joints (flared joints) with thermal insulation tubing as shown below.

[Fig. 6-9] (P.3)

Ⓐ Pipe cover (small) (accessory)

Ⓑ Caution:

Pull out the thermal insulation on the refrigerant piping at the site, insert the flare nut to flare the end, and replace the insulation in its original position.

Take care to ensure that condensation does not form on exposed copper piping.

- | | |
|---|-------------------------------------|
| Ⓒ Liquid end of refrigerant piping | Ⓓ Gas end of refrigerant piping |
| Ⓔ Site refrigerant piping | Ⓕ Main body |
| Ⓖ Pipe cover (large) (accessory) | Ⓖ Thermal insulation (field supply) |
| Ⓗ Pull | Ⓗ Flare nut |
| Ⓙ Return to original position | Ⓙ Ensure that there is no gap here |
| Ⓜ Plate on main body | Ⓜ Band (accessory) |
| Ⓞ Ensure that there is no gap here. Place join upwards. | |

- Remove and discard the rubber bung which is inserted in the end of the unit piping.
- Flare the end of the site refrigerant piping.
- Pull out the thermal insulation on the site refrigerant piping and replace the insulation in its original position.

Cautions On Refrigerant Piping

- Be sure to use non-oxidative brazing for brazing to ensure that no foreign matter or moisture enter into the pipe.
- Be sure to apply refrigerating machine oil over the flare connection seating surface and tighten the connection using a double spanner.
- Provide a metal brace to support the refrigerant pipe so that no load is imparted to the indoor unit end pipe. This metal brace should be provided 50 cm away from the indoor unit's flare connection.

6.4. Purging procedures leak test

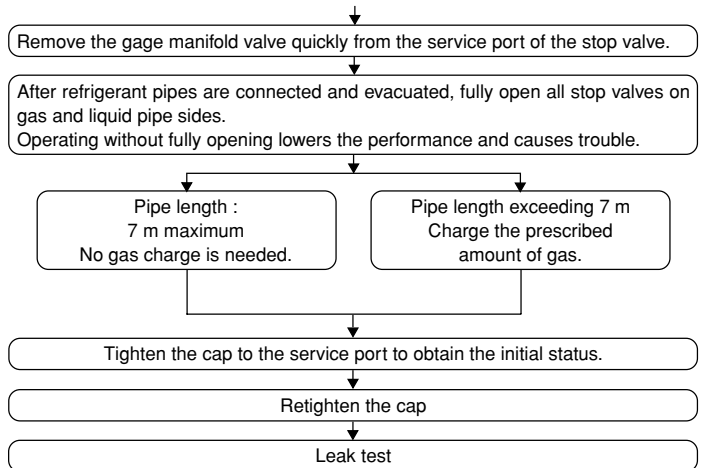
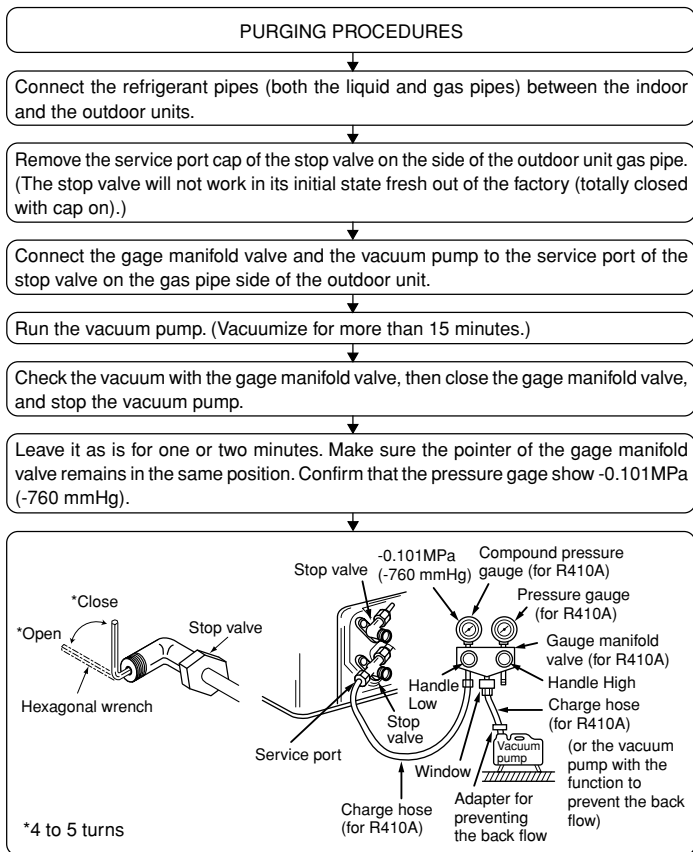

6.5. Drain piping work

- Ensure that the drain piping is downward (pitch of more than 1/100) to the outdoor (discharge) side. Do not provide any trap or irregularity on the way. (①)
- Ensure that any cross-wise drain piping is less than 20 m (excluding the difference of elevation). If the drain piping is long, provide metal braces to prevent it from waving. Never provide any air vent pipe. Otherwise drain may be ejected.
- Use a hard vinyl chloride pipe O.D. ø32 for drain piping.
- Ensure that collected pipes are 10 cm lower than the unit body's drain port as shown in ②.
- Do not provide any odor trap at the drain discharge port.
- Put the end of the drain piping in a position where no odor is generated.
- Do not put the end of the drain piping in any drain where ionic gases are generated.
- After connecting the drain piping, make sure that water is discharged properly and that there are no leaks.

[Fig. 6-10] (P.3)

- Ⓐ Downward slope 1/100 or more
- Ⓑ Connection dia. R1 external thread
- Ⓒ Indoor unit
- Ⓓ Collective piping
- Ⓔ Maximize this length to approx. 10 cm

- Insert the drain hose (accessory) into the drain port. (The drain hose must not be bent more than 45° to prevent the hose from breaking or clogging.)
The connecting part between the indoor unit and the drain hose may be disconnected at the maintenance. Fix the part with the accessory band, not be adhered.
- Attach the drain pipe (O.D. ø32 PVC TUBE, field supply). (Attach the pipe with glue for the hard vinyl chloride pipe, and fix it with the band (small, accessory).)
- Perform insulation work on the drain pipe (O.D. ø32 PVC TUBE) and on the socket (including elbow).

[Fig. 6-11] (P.3)

- Ⓐ Indoor unit
- Ⓑ Pipe cover (short) (accessory)
- Ⓒ Tie band (accessory)
- Ⓓ Band fixing part
- Ⓔ Insertion margin
- Ⓕ Drain hose (accessory)
- Ⓖ Drain pipe (O.D. ø32 PVC TUBE, field supply)
- Ⓗ Insulating material (field supply)
- Ⓚ Max. 145 ± 5 mm

7. Duct work

- When connecting ducts, insert a canvas duct between the main body and the duct.
- Use non-combustible duct components.

⚠ Caution:

- **The noise from the intake will increase dramatically if intake ④ is fitted directly beneath the main body. Intake ④ should therefore be installed as far away from the main body as possible. Particular care is required when using it with bottom inlet specifications.**
- **Install sufficient thermal insulation to prevent condensation forming on outlet duct flanges and outlet ducts.**
- **To connect the air conditioner main body and the duct for potential equalization.**

8. Electrical work

8.1. Power supply

Electrical specification	Input capacity Main Switch/Fuse (A)				
Power supply (1 phase ~N, 230V, 50Hz)	SEZ-KD25	SEZ-KD35	SEZ-KD50	SEZ-KD60	SEZ-KD71
	10	10	20	20	20

⚠ Warning:

- **The compressor will not operate unless the power supply phase connection is correct.**
- **Grounding protection with a no-fuse breaker (earth leakage breaker [ELB]) is usually installed for ⑥.**
- **The connection wiring between the outdoor and indoor units can be extended up to a maximum of 50 meters, and the total extension including the crossover wiring between rooms is a maximum of 80 m.**

A switch with at least 3 mm contact separation in each pole shall be provided by the air conditioner installation.

* **Label each breaker according to purpose (heater, unit etc.).**

[Fig. 8-1] (P.4)

- ① Indoor unit
- ② Outdoor unit
- ③ Wired remote controller
- ④ Main switch/fuse
- ⑤ Grounding

8.2. Indoor wire connection

Work procedure

1. Remove 2 screws to detach the electric component cover.
 2. Route each cable through the wiring intake into the electric component box. (Procure power cable and in-out connecting cable locally and use remote control cable supplied with the unit.)
 3. Securely connect the power cable and the in-out connecting cable and the remote control cable to the terminal blocks.
 4. Secure the cables with clamps inside the electric component box.
 5. Attach the electric component cover as it was.
- Fix power supply cable and indoor/outdoor cable to control box by using buffer bushing for tensile force. (PG connection or the like.)

⚠ Warning:

- **Attach the electrical part cover securely. If it is attached incorrectly, it could result in a fire, electric shock due to dust, water, etc.**
- **Use the specified indoor/outdoor unit connecting wire to connect the indoor and outdoor units and fix the wire to the terminal bed securely so that no stress is applied to the connecting section of the terminal bed. Incomplete connection or fixing of the wire could result in a fire.**

[Fig. 8-2-1] (P.4)

- ① Screw holding cover (2pcs)
- ② Cover

[Fig. 8-2-2] (P.4)

- ① Terminal bed box
- ② Knockout hole
- ③ Remove

[Fig. 8-2-3] (P.4)

- ① Use PG bushing to keep the weight of the cable and external force from being applied to the power supply terminal connector. Use a cable tie to secure the cable.
- ② Power source wiring
- ③ Tensile force
- ④ Use ordinary bushing
- ⑤ Transmission wiring

- **Keep the distance between the inlet grille and the fan over 850 mm. If it is less than 850 mm, install a safety guard not to touch the fan.**

[Fig. 7-1] (P.4)

- ① Air inlet
- ② Air outlet
- ③ Access door
- ④ Ceiling surface
- ⑤ Canvas duct
- ⑥ Air filter
- ⑦ Inlet grille

[Fig. 8-2-4] (P.4)

- ① Terminal bed for power source and indoor transmission
- ② Terminal bed for remote controller
- ③ To 1-phase power source
- ④ Transmission line to the remote controller

- Perform wiring as shown in the diagram to the lower left. (Procure the cable locally.) Make sure to use cables of the correct polarity only.

[Fig. 8-3] (P.5)

- ① Indoor terminal block
- ② Earth wire (green/yellow)
- ③ Indoor/outdoor unit connecting wire 3-core 1.5 mm² or more
- ④ Outdoor terminal block
- ⑤ Power supply cord : 2.0 mm² or more
- ⑥ Connecting cable
Cable 3-core 1.5 mm², in conformity with Design 245 IEC 57.
- ⑦ Indoor terminal block
- ⑧ Outdoor terminal block
- ⑨ Always install an earth wire (1-core 1.5 mm²) longer than other cables
- ⑩ Remote controller cable
Wire No × size (mm²) : Cable 2C × 0.3
This wire accessory of remote controller
(wire length : 10 m, non-polar. Max. 500 m)
- ⑪ Wired remote controller
- ⑫ Power supply cord
Cable 3-core 2.0 mm² or more, in conformity with Design 245 IEC 57.

- Connect the terminal blocks as shown in the diagram below.

⚠ Caution:

- **Use care not to make mis-wiring.**
- **Firmly tighten the terminal screws to prevent them from loosening.**
- **After tightening, pull the wires lightly to confirm that they do not move.**

8.3. Remote controller

8.3.1. For wired remote controller

1) Installing procedures

(1) Select an installing position for the remote controller.

The temperature sensors are located on both remote controller and indoor unit.

► Procure the following parts locally:

- Two piece switch box
- Thin copper conduit tube
- Lock nuts and bushings

[Fig. 8-4] (P.5)

- ① Remote controller profile
- ② Required clearances surrounding the remote controller
- ③ Installation pitch

(2) Seal the service entrance for the remote controller cord with putty to prevent possible invasion of dew drops, water, cockroaches or worms.

[Fig. 8-5] (P.5)

- ① For installation in the switch box:
- ② For direct installation on the wall select one of the following:
 - Prepare a hole through the wall to pass the remote controller cord (in order to run the remote controller cord from the back), then seal the hole with putty.
 - Run the remote controller cord through the cut-out upper case, then seal the cut-out notch with putty similarly as above.
- ③ Wall
- ④ Conduit
- ⑤ Lock nut
- ⑥ Bushing
- ⑦ Switch box
- ⑧ Remote controller cord
- ⑨ Seal with putty
- ⑩ Wood screw

B-1. To lead the remote controller cord from the back of the controller:

B-2. To run the remote controller cord through the upper portion:

(3) For direct installation on the wall

8. Electrical work

2) Connecting procedures

- ① Connect the remote controller cord to the terminal block.

[Fig. 8-6] (P.5)

- Ⓐ To the terminal block on the indoor unit
- Ⓑ TB6 (No polarity)
- ② Set the dip switch No.1 shown below when using two remote controller's for the same group.

3) Function selection of remote controller

If two remote controllers are connected, set one to "Main" and the other to "Sub". For setting procedures, refer to "Function selection of remote controller" in the operation manual for the indoor unit.

8.4. Outdoor unit

[Fig. 8-7] (P.5)

- Connect cable from the indoor unit correctly on the terminal-block.
- Use the same terminal block and polarity as is used with the indoor unit.
- For aftercare maintenance, give extra length to connecting cable.

- Both end of connecting cable (extension wire) are peeled off. When too long, or connected by cutting off the middle, peel off power supply cable to the size given in the figure.
- Be careful not to contact connecting cable with piping.

[Fig. 8-8] (P.5)

- Ⓐ Loosen terminal screw
- Ⓑ Terminal block
- Ⓒ Lead wire

⚠ Caution:

- Use care not to make mis-wiring. (Fig. 8-8)
- Firmly tighten the terminal screws to prevent them from loosening.
- After tightening, pull the wires lightly to confirm that they do not move.

⚠ Warning:

- Be sure to attach the service panel of the outdoor unit securely. If it is not attached correctly, it could result in a fire or an electric shock due to dust, water, etc.
- Tighten terminal screws securely.
- Wiring should be done so that the power lines are not subject to tension. Otherwise, heat may be generated or fire may occur.

Function table

Select unit number 00

Mode	Settings	Mode no.	Setting no.	Initial setting	Setting
Power failure automatic recovery*1 (AUTO RESTART FUNCTION)	Not available	01	1	○ (*1)	
	Available		2		
Indoor temperature detecting	Indoor unit operating average	02	1	○	
	Set by indoor unit's remote controller		2		
	Remote controller's internal sensor		3		
LOSSNAY connectivity	Not Supported	03	1	○	
	Supported (indoor unit is not equipped with outdoor-air intake)		2		
	Supported (indoor unit is equipped with outdoor-air intake)		3		
Auto mode	Energy saving cycle automatically enabled	05	1	○	
	Energy saving cycle automatically disabled		2		

Select unit numbers 01 to 03 or all units (AL [wired remote controller]/07 [wireless remote controller])

Mode	Settings	Mode no.	Setting no.	Initial setting	Setting
Filter sign	100 Hr	07	1		
	2500 Hr		2		
	No filter sign indicator		3	○	
External static pressure	15 Pa	08	1	○	
	35 Pa		2		
	50 Pa		3		
	The same as setting of mode no.08	10	1	○	
5 Pa (set mode no. 08 to 1)	2				

*1 When the power supply returns, the air conditioner will start 3 minutes later.

8.5. Function settings

8.5.1 Function setting on the unit (Selecting the unit functions)

1) AUTO RESTART FUNCTION

For wired remote controller only (Fig. 8-9)

This model is equipped with the AUTO RESTART FUNCTION.

When the indoor unit is controlled with the remote controller, the operation mode, set temperature, and the fan speed are memorized by the indoor controller board. The auto restart function sets to work the moment the power has restored after power failure, then, the unit will restart automatically.

2) Other functions

For wired remote controller only [Fig. 8-9] (P.6)

- ① Mode number
- Ⓐ Setting number
- Ⓑ Refrigerant address
- Ⓒ Unit number
- Ⓓ Filter ↓ button (<Enter> button)
- Ⓔ TEST button
- Ⓕ Set Time button
- Ⓖ Timer On/Off button (Set Day button)
- Ⓗ Mode selection button
- Ⓘ Set temperature button
- Ⓚ Timer Menu button (Monitor/Set button)

Changing the external static pressure setting

- Be sure to change the external static pressure setting depending on the duct and the grill used.

- ① Go to the function setting mode.
Switch OFF the remote controller.
Press the Ⓐ and Ⓑ buttons simultaneously and hold them for at least 2 seconds. FUNCTION will start to flash.
- ② Use the Ⓒ button to set the refrigerant address (Ⓜ) to 00.
- ③ Press Ⓓ and [←] will start to flash in the unit number (Ⓜ) display.
- ④ Use the Ⓒ button to set the unit number (Ⓜ) to 00.
- ⑤ Press the Ⓗ MODE button to designate the refrigerant address/unit number.
[←] will flash in the mode number (Ⓜ) display momentarily.
- ⑥ Press the Ⓘ buttons to set the mode number (Ⓜ) to 08 or 10.
- ⑦ Press the Ⓚ button and the current set setting number (Ⓜ) will flash.
Use the Ⓘ button to switch the setting number in response to the external static pressure to be used.

External static pressure	Setting no. of mode no. 08	Setting no. of mode no. 10
5 Pa	1	2
15 Pa (before shipment)	1	1
35 Pa	2	1
50 Pa	3	1

- ⑧ Press the MODE button Ⓗ and mode and the setting number (Ⓜ) and (Ⓜ) will change to being on constantly and the contents of the setting can be confirmed.
- ⑨ Press the FILTER Ⓓ and TEST RUN Ⓔ buttons simultaneously for at least two seconds. The function selection screen will disappear momentarily and the air conditioner OFF display will appear.

9. Test run

9.1. Before test run

- ▶ After completing installation and the wiring and piping of the indoor and outdoor units, check for refrigerant leakage, looseness in the power supply or control wiring, wrong polarity, and no disconnection of one phase in the supply.
- ▶ Use a 500-volt megohmmeter to check that the resistance between the power supply terminals and ground is at least 1.0 MΩ.
- ▶ Do not carry out this test on the control wiring (low voltage circuit) terminals.

⚠ Warning:

Do not use the air conditioner if the insulation resistance is less than 1.0 MΩ. Insulation resistance

After installation or after the power source to the unit has been cut for an extended period, the insulation resistance will drop below 1 MΩ due to refrigerant accumulating in the compressor. This is not a malfunction. Perform the following procedures.

1. Remove the wires from the compressor and measure the insulation resistance of the compressor.
2. If the insulation resistance is below 1 MΩ, the compressor is faulty or the resistance dropped due the accumulation of refrigerant in the compressor.
3. After connecting the wires to the compressor, the compressor will start to warm up after power is supplied. After supplying power for the times indicated below, measure the insulation resistance again.
 - The insulation resistance drops due to accumulation of refrigerant in the compressor. The resistance will rise above 1 MΩ after the compressor is warmed up for two to three hours.
(The time necessary to warm up the compressor varies according to atmospheric conditions and refrigerant accumulation.)
 - To operate the compressor with refrigerant accumulated in the compressor, the compressor must be warmed up at least 12 hours to prevent breakdown.
4. If the insulation resistance rises above 1 MΩ, the compressor is not faulty.

⚠ Caution:

- **The compressor will not operate unless the power supply phase connection is correct.**
- **Turn on the power at least 12 hours before starting operation.**
- Starting operation immediately after turning on the main power switch can result in severe damage to internal parts. Keep the power switch turned on during the operational season.

• For description of each check code, refer to the following table.

① Check code	Symptom	Remark
P1	Intake sensor error	
P2, P9	Pipe (Liquid or 2-phase pipe) sensor error	
E6, E7	Indoor/outdoor unit communication error	
P4	Drain sensor error	
P5	Drain pump error	
PA	Forced compressor error	
P6	Freezing/Overheating safeguard operation	
EE	Communication error between indoor and outdoor units	
P8	Pipe temperature error	
E4	Remote controller signal receiving error	
Fb	Indoor unit control system error (memory error, etc.)	
E0, E3	Remote controller transmission error	
E1, E2	Remote controller control board error	
E9	Indoor/outdoor unit communication error (Transmitting error) (Outdoor unit)	
UP	Compressor overcurrent interruption	
U3, U4	Open/short of outdoor unit thermistors	
UF	Compressor overcurrent interruption (When compressor locked)	
U2	Abnormal high discharging temperature/49C worked/insufficient refrigerant	
U1, Ud	Abnormal high pressure (63H worked)/Overheating safeguard operation	
U5	Abnormal temperature of heat sink	For details, check the LED display of the outdoor controller board.
U8	Outdoor unit fan safeguard stop	
U6	Compressor overcurrent interruption/Abnormal of power module	
U7	Abnormality of super heat due to low discharge temperature	
U9, UH	Abnormality such as overvoltage or voltage shortage and abnormal synchronous signal to main circuit/ Current sensor error	
Others	Other errors (Refer to the technical manual for the outdoor unit.)	

• On wired remote controller

- ① Check code displayed in the LCD.

9.2. Test run

9.2.1. Using wired remote controller

- ① Turn on the power at least 12 hours before the test run.
- ② Press the [TEST] button twice. ➡ "TEST RUN" liquid crystal display
- ③ Press the [Mode selection] button. ➡ Make sure that wind is blown out.
- ④ Press the [Mode selection] button and switch to the cooling (or heating) mode.
➡ Make sure that cold (or warm) wind is blown out.
- ⑤ Press the [Fan speed] button. ➡ Make sure that the wind speed is switched.
- ⑥ Check operation of the outdoor unit fan.
- ⑦ Release test run by pressing the [ON/OFF] button. ➡ Stop
- ⑧ Register a telephone number.

The telephone number of the repair shop, sales office, etc., to contact if an error occurs can be registered in the remote controller. The telephone number will be displayed when an error occurs. For registration procedures, refer to the operation manual for the indoor unit.

[Fig. 9-1] (P.6)

- Ⓐ ON/OFF button
- Ⓑ Test run display
- Ⓒ Indoor temperature liquid line temperature display
- Ⓓ ON/OFF lamp
- Ⓔ Power display
- Ⓕ Error code display
- Ⓖ Test run remaining time display
- Ⓗ Set temperature button
- Ⓘ Mode selection button
- Ⓚ Fan speed button
- Ⓛ TEST button

9.3. Self-check

9.3.1. Wired remote controller

- ① Turn on the power.
- ② Press the [CHECK] button twice.
- ③ Set refrigerant address with [TEMP] button if system control is used.
- ④ Press the [ON/OFF] button to stop the self-check.

[Fig. 9-2] (P.6)

- Ⓐ CHECK button
- Ⓑ Refrigerant address
- Ⓒ TEMP. button
- Ⓓ IC: Indoor unit
OC: Outdoor unit
- Ⓔ Check code

9. Test run

9.4. AUTO RESTART FUNCTION

Indoor controller board

This model is equipped with the AUTO RESTART FUNCTION.

When the indoor unit is controlled with the remote controller, the operation mode, set temperature, and the fan speed are memorized by the indoor controller board. The auto restart function sets to work the moment the power has restored after power failure, then, the unit will restart automatically.

Set the AUTO RESTART FUNCTION using the remote controller. (Mode no.1)

10. Maintenance

10.1. Gas charge

[Fig. 10-1] (P.6)

- Ⓐ Indoor unit
- Ⓑ Union
- Ⓒ Liquid pipe
- Ⓓ Gas pipe
- Ⓔ Stop valve
- Ⓕ Outdoor unit
- Ⓖ Refrigerant gas cylinder operating valve
- Ⓗ Refrigerant gas cylinder for R410A with siphon
- Ⓛ Refrigerant (liquid)
- Ⓜ Electronic scale for refrigerant charging
- Ⓝ Charge hose (for R410A)
- Ⓦ Gauge manifold valve (for R410A)
- Ⓢ Service port

1. Connect gas cylinder to the service port of stop valve (3-way).
2. Execute air purge of the pipe (or hose) coming from refrigerant gas cylinder.
3. Replenish specified amount of refrigerant, while running the air conditioner for cooling.

Note:

In case of adding refrigerant, comply with the quantity specified for the refrigerating cycle.

⚠ Caution:

- Do not discharge the refrigerant into the atmosphere. Take care not to discharge refrigerant into the atmosphere during installation, reinstallation, or repairs to the refrigerant circuit.
- For additional charging, charge the refrigerant from liquid phase of the gas cylinder. If the refrigerant is charged from the gas phase, composition change may occur in the refrigerant inside the cylinder and the outdoor unit. In this case, ability of the refrigerating cycle decreases or normal operation can be impossible. However, charging the liquid refrigerant all at once may cause the compressor to be locked. Thus, charge the refrigerant slowly.

To maintain the high pressure of the gas cylinder, warm the gas cylinder with warm water (under 40°C) during cold season. But never use naked fire or steam.

This product is designed and intended for use in the residential,
commercial and light-industrial environment.

The product at hand is based on the following EU regulations:

- Low Voltage Directive 2006/95/ EC
- Electromagnetic Compatibility Directive 89/336/ EEC, 2004/108/ EC

Please be sure to put the contact address/telephone number on
this manual before handing it to the customer.