



DIAMOND VIEW DV156

Colour TFT LCD Monitor
15" (38.4 cm) LCD Panel Size

Table of Contents

1	Important Safety Instructions.....	3
2	Features	4
3	Unpacking the Monitor.....	5
4	Hardware Installation	6
	Audio Cable Installation	7
5	Windows Software Installation.....	8
	Windows 95.....	8
	Windows 98.....	8
	Windows Millennium Edition (Windows Me)	9
	Windows 2000.....	9
6	Setting the Display Resolution.....	10
	Choosing The Best Resolution	10
	Supported Graphics Modes and Refresh Rate Selection	11
7	Adjusting the Monitor	13
	Picture Optimisation.....	13
	Manual Picture Adjustment.....	13
8	Security Lock Installation	16
9	Frequently Asked Questions	17
10	Specifications	19
11	Service Contacts	21
	Australia.....	21
	New Zealand	22

Copyright Notice

Copyright 2001, Mitsubishi Electric Australia Pty. Ltd. All rights reserved. No part of this publication may be reproduced, transmitted, transcribed, stored in a retrieval system or translated into any language or computer language, in any form or by any means, electronic, mechanical, magnetic, optical, chemical, manual or otherwise, without the prior written permission.

Disclaimer

Mitsubishi Electric Australia Pty. Ltd. makes no representations or warranties, either expressed or implied, with respect to the contents hereof and specifically disclaims any warranties, merchantability or fitness for any particular purpose. Further, Mitsubishi Electric Australia reserves the right to revise this publication and to make changes from time to time in the contents hereof without obligation to notify any person of such revision or changes.

Diamond View is a registered trademark of Mitsubishi Electric Australia Pty. Ltd. Microsoft and Windows are registered trademarks of Microsoft Corporation. All other trademarks remain the property of their respective owners.

Reference Information	
For future reference, write the following information about your monitor in the space below. The serial number is on the back of the product or on the bottom of its stand.	
Monitor Information	
Product Name:	Diamond View DV156
Serial Number:	_____
Date of Purchase:	_____
Dealer Information	
Dealer:	_____
Telephone Number:	_____
Address:	_____

I Important Safety Instructions

Please read the following safety instructions before installing or cleaning your Diamond View monitor:

1. Unplug the monitor's power cable from the wall outlet before cleaning. Do not use liquid or aerosol cleaners. Use a soft cloth to clean the monitor housing and a tape to stick dust and fingerprints on the screen panel.
2. Slots and openings on the back or top of the cabinet are provided for ventilation. They must not be blocked or covered. This product should never be placed near or over a radiator or other heat source, or in a built-in installation unless proper ventilation is provided.
3. Never push objects of any kind, or spill liquid of any kind into this product.
4. Do not attempt to service this product yourself as opening or removing covers may expose you to dangerous voltages or other risks.
5. If any abnormal operation or accident (such as dropping the unit) occurs, disconnect the monitor from the wall power outlet and contact qualified service personnel.
6. Turn the audio volume control of the built-in speakers to minimum (0) and turn the monitor off before connecting or disconnecting any audio cable.

Features

Your Diamond View DV156 Monitor features:

- ◆ **XGA (1024 x 768 pixel) Resolution LCD Panel**
- ◆ **High Brightness – 250 cd/m²**
- ◆ **Very High Contrast Ratio – 400:1**
- ◆ **True Colour Display**
With dithering support, Diamond View DV156 monitor enhances the visual effect and offers you better image quality.
- ◆ **High Quality Ratiometric Expansion**
With any resolution within the monitor's specified range, your Diamond View DV156 monitor can expand the image to full screen.
- ◆ **Auto Adjustment Function**
The auto adjustment key automatically optimises the displayed image.
- ◆ **Plug and Play Compatibility wth Microsoft® Windows®**
- ◆ **Space Saving - only 186 mm deep**
- ◆ **Light Weight - only 5.8 kg**
- ◆ **Lower Power Consumption**
36 W maximum during operation with audio.
- ◆ **Power Saving**
Power management complies with VESA DPMS standard. When the system is idle (in monitor off mode), the monitor automatically cuts its power consumption to less than 5 W.
- ◆ **On Screen Display**
Allows you to adjust all settings simply using on-screen menus.
- ◆ **Removable Stand with VESA Standard Mounting**
- ◆ **Built-in Stereo Amplifier and Speakers**

3 Unpacking the Monitor

Please check that the following items are included with your monitor. If they are missing or damaged, please contact your place of purchase immediately.

- ◆ **LCD monitor with attached signal cable**
- ◆ **Power cord**
- ◆ **User's manual**
- ◆ **Audio Cable**
- ◆ **Utilities and Driver Floppy Diskette**

Locate the model name and the serial number label on the back of your monitor and write the details of the monitor and your place of purchase in the space on page (ii) of this manual for future reference.

4 Hardware Installation

Your monitor is equipped with an automatic power supply with a voltage range from 90 to 264 Volts AC at a frequency of 50 to 60 Hz. Make sure that your local power supply is within the supported range. If you are unsure, please contact your electricity supplier.

To install your Diamond View DV156 monitor:

1. Make sure that the power to the computer and the power to the monitor are both turned off.
2. Connect the blue connector of the monitor's VGA cable to the VGA output of the computer's graphics card.
3. Connect the monitor's power cord to an AC power socket. Please make sure, that you have easy access to the power socket so you can disconnect the unit from the power socket should you need to.

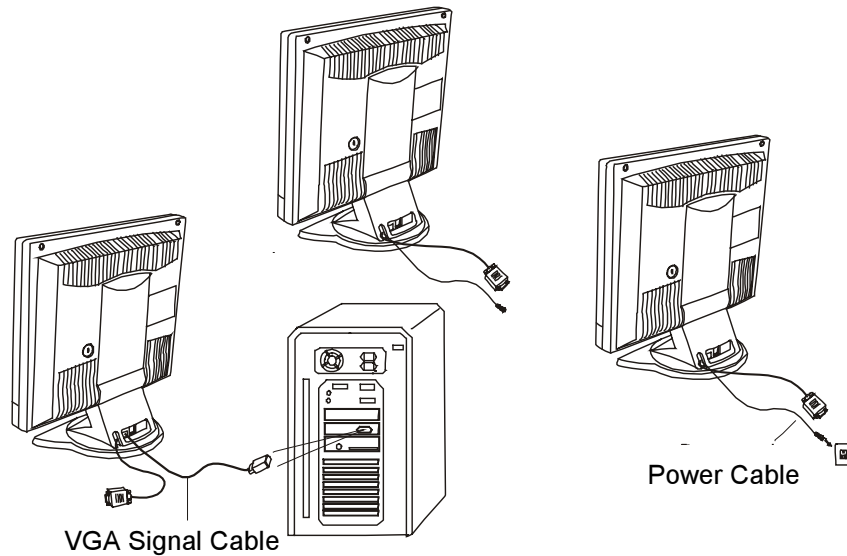

Audio Cable Installation

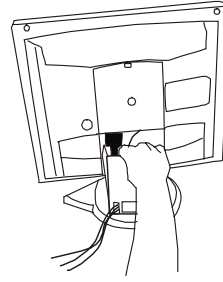
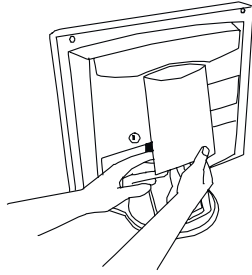

1. Remove the rear cover and then take the base cover off.

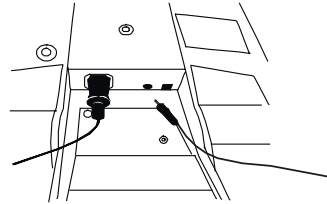
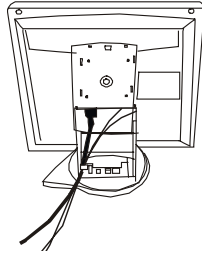

2. Connect the stereo audio cable from the Audio output of your sound card to the Audio Input of the monitor.

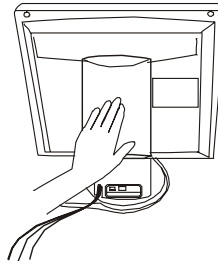
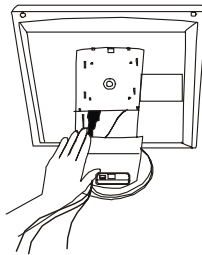

3. Replace the base cover and the rear cover.

5 Windows Software Installation

To get best performance with Windows 95, 98, Millennium Edition or 2000 you should use the Windows driver supplied with your DV156 monitor.

Windows 95

The first time you start Windows after connecting your new monitor, the system will detect it and automatically install the driver for Plug and Play displays. To install the Diamond View DV156 driver and colour profile:

1. Insert the *Diamond View LCD Monitor Utilities* floppy disk into your floppy disk drive.
2. Right-click on the Windows desktop and select **Properties** or open the Control Panel and double-click **Display**.
3. From the **Display Properties** window, select the **Settings** tab and then click the **Advanced Properties** button at the bottom, right corner.
4. Select the **Monitor** tab and then click the **Change** button.
5. Click the **Have Disk** button at the bottom right corner. The **Install From Disk** window will appear with the floppy drive **A:** selected. Click **OK**.
6. Select **DV156** from the list and click **OK** again to install the driver.
7. You will be returned to the **Advanced Graphics Properties** dialogue. Close this window by clicking **OK** and confirm the subsequent messages by clicking **Yes**. Click **OK** and then **Yes** once more.
8. The installation is now complete, click **OK** to close **Display Properties**.

Windows 98

The first time you start Windows with a new monitor, the system will detect it and automatically start the **Add New Hardware** wizard.

1. Click the Next button. Select Search for the best driver for your device (recommended) and click Next.
2. Insert the *Diamond View LCD Monitor Utilities* floppy disk into your floppy disk drive. Select the **Floppy disk drive** check box and click **Next**.

3. Click **Next** again and then click **Continue**. The driver and monitor colour profile will be installed. Click **Finish** to complete the installation.

Windows Millennium Edition (Windows Me)

The first time you start Windows with a new monitor, the system will detect it and automatically start the **Add New Hardware** wizard.

1. Insert the *Diamond View LCD Monitor Utilities* floppy disk into your floppy disk drive. Select the **Floppy disk drive** check box and click **Next**.
2. Select Search for the best driver for your device (recommended), tick the Removable Media (Floppy, CD-ROM,...) and click Next.
3. Click **Next** again and then **Finish** to complete the installation.

Windows 2000

If the system will detects your DV156 monitor automatically and starts the **Add new hardware wizard**, carry out these instructions beginning at step 7. Otherwise, to install the monitor driver and ICC colour profile:

1. Click **Start** and then **Settings** and open the **Control Panel**.
2. Double click the **Display** icon.
3. From the **Display Properties** dialogue box, select the **Settings** tab. Click the **Advanced....** button at the bottom, right corner.
4. Select **Monitor** then click **Properties**.
5. Select the **Driver** tab and click **Update Driver**.
6. The **Upgrade Device Driver Wizard** will pop start. Click **Next**.
7. Insert the *Diamond View LCD Monitor Utilities* disk into your floppy disk drive.
8. Select **Display a list of the known drivers for this device so that I can choose a specific driver** and click **Next**.
9. In the next window, click **Have Disk**. The **Install From Disk** dialogue will open. The default drive is the floppy disk drive, **A:**. Click **OK**.
10. Select the DV156 LCD monitor from the list and then click **Next** twice.
11. The **Digital Signature Not Found** window will appear. Click **Yes** and then click **Finish** to complete the driver installation.

6 Setting the Display Resolution

Choosing The Best Resolution

All Liquid Crystal Displays (LCDs) have a fixed resolution that is the same as the maximum resolution that may be displayed on the LCD. In the case of the DV156 the LCD resolution is 1024 x 768 pixels. This is also known as the **native** resolution of the monitor. Lower resolutions can be displayed at full screen through an interpolation circuit. Because the lower resolution must be expanded, the quality of the displayed image is not as good as that available when the native resolution is displayed. For optimal performance from any LCD monitor, you must use the monitor's native resolution.

If you are using Windows 95, 98, 2000, Me or NT 4.0, you can change the resolution as follows:

1. Double-click the **Display** icon in the control panel.
2. From the **Display Properties** dialogue box, select the **Settings** tab. There is a slider on the right-hand side in the middle of the dialogue that alters the displayed resolution. Set the resolution to 1024x768.
3. *For Windows NT users only:* select a refresh rate of either 60 Hz or 75 Hz and click **Test**. A test pattern will be displayed. Make sure that there are no error messages shown by the monitor. If an error message is displayed, check the resolution and refresh rate settings or choose a different refresh rate.
4. Click **OK** to close **Display Properties**.

If you are using an Apple Macintosh, you may change the resolution by:

1. Click the Apple icon at the top, left corner of the screen, select **Control Panel** and then select **Monitors & Sound**.
2. Select a resolution of 1024 x 768 pixels with either 60 Hz or 75 Hz refresh rate.
3. If refresh rates of 60 Hz or 75 Hz are not available, click **Recommended** in the **Show** drop-down box and change it to **All**. Select the resolution and refresh rate as above.
4. A colour depth of either **Thousands** or **Millions** is recommended.

Supported Graphics Modes and Refresh Rate Selection

There is no need to choose the highest possible refresh rate when using an LCD monitor. It is not technically possible for an LCD monitor to flicker. Even at a refresh rate of 60 Hz you will get an absolutely flicker-free image.

For best results, it is important that you set the graphics adaptor to use one of the monitor's preset display modes shown in **Table 1** on the next page. Other graphics signals may be displayed poorly or not at all. Note that the DV156's preset modes correspond to VESA or Apple Macintosh standard graphics signals for these resolutions. All recent models of graphics adaptor should be able to support these modes. For the native resolution of 1024 x 768 pixels, for example, refresh rates of 60, 70 and 75 Hertz are supported.

With Windows 95, 98, 2000 or Millennium Edition you can change the refresh rate of the graphics signal as follows:

1. Double click the **Display** icon in the control panel.
2. From the **Display Properties** dialogue, select the **Settings** tab and click the **Advanced Properties** button.
3. Select the **Adapter** tab. The refresh rate selection field is located in the centre, at the bottom of the dialogue box.
4. Choose a refresh rate that corresponds with one of the factory modes from the table below.
5. Click **Apply**, and then **OK** twice.

Please Note:

- Graphics modes that are not listed in the table may not be supported. For an optimal picture it is recommended that you choose a graphics mode with a resolution of 1024 x 768 pixels that is listed in **Table 1** on the next page. Resolutions of 640 x 480, 800 x 600, 832 x 624 and 1024 x 768 pixels are supported. Signals marked with an asterisk (*) are not pre-adjusted in the factory. The default setting may require some adjustment before use.
- The displayed image may show some distortion or noise that can be caused by the signal from the VGA card if it does not correspond with the usual standard. This is not, however, a problem with the monitor. If it is still visible after using the Automatic adjustment, you can usually improve the displayed image by manually adjusting the phase, horizontal position and pixel frequency settings using the "Geometry" menu. See Chapter 7, **Adjusting the Monitor**, for more details.

- When you shut Windows down you may see interference lines on your screen. This caused by the manner in which Windows controls the graphics card at this point and is normal with all LCD monitors.
- To extend the service life of the product, we recommend that you use your computer's power management functions to turn the monitor off after extended idle periods.

Input Signal					
Resolution	Horizontal Frequency (kHz)	Vertical Frequency (Hz)	Pixel Frequency (MHz)	Comment	Actual Display Resolution
640x350*	31.47(P)	70.08(N)	25.17	DOS	1024 x 675
640x480	31.47(N)	59.94(N)	25.18	DOS	Full image 1024 x 768
640x480	35.00(N)	67.00(N)	30.24	Macintosh	
640x480	37.50(N)	75.00(N)	31.50	VESA	
640x480*	37.86(N)	72.80(N)	31.50	VESA	
720x400	31.47(N)	70.08(P)	28.32	DOS	
800x600*	35.16(P)	56.25(P)	36.00	VESA	
800x600*	37.88(P)	60.31(P)	40.00	VESA	
800x600*	48.08(P)	72.19(P)	50.00	VESA	
800x600	46.87(P)	75.00(P)	49.50	VESA	
832x624	49.72(N)	74.55(N)	57.29	Macintosh	
1024x768	48.36(N)	60.00(N)	65.00	VESA	
1024x768	56.48(N)	70.10(N)	75.00	VESA	
1024x768	60.02(P)	75.03(P)	78.75	VESA	
1024x768	60.24(N)	74.93(P)	80.00	Macintosh	

Table 1

7 Adjusting the Monitor

Picture Optimisation

The easiest way to obtain an optimal picture is by using the **AUTO** button. This only works reliably if the graphics adaptor is set to use one of the monitor's factory modes (see **Table 1** in the previous chapter) and if you are displaying an appropriate full-screen test pattern.

Windows users should run the adjustment software (Auto.exe) from the Utilities floppy disk to display the correct test pattern. Press the Auto button once the test pattern is displayed. You can quit Auto.exe by clicking the left mouse button once and clicking on **Exit**.

Test patterns in TIFF and JPEG file formats are also available from the File Downloads section of Mitsubishi Electric Australia's web site at www.mitsubishi-electric.com.au. Follow the link to the TFT LCD monitors page and download a pattern with the resolution that you need. Display the test pattern at its actual size (100% zoom), preferably at full screen and then press the monitor's Auto button.

If you are still not satisfied with the result, you can enhance the image by using the monitor's manual adjustment functions.

Manual Picture Adjustment

Adjustments to the displayed image and audio volume are made using the On-Screen Display (OSD), three buttons and the adjustment wheel on the front of the monitor.

The user's controls include Power, AUTO, Exit and Enter. The rotary control or wheel is used to select menu items and to change the values of image parameters.

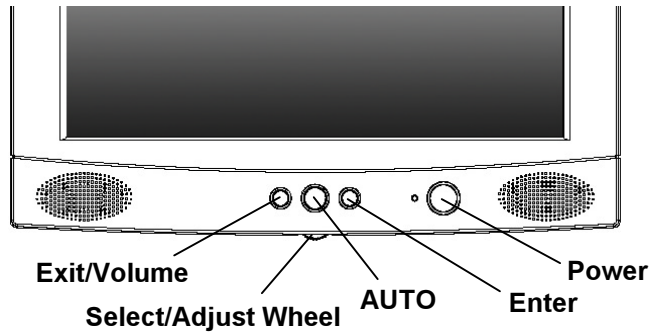

- Power:** Turn the monitor on or off.
- AUTO:** Automatically adjusts the vertical position, pixel phase, horizontal position and pixel clock.
- Exit:** Return to the main menu or exit the OSD menu without saving. Press the exit key when the OSD is not displayed to adjust the audio volume.
- Enter:** Enter sub-menus, select items, save changes.
- Wheel:** Turn this to select a menu item or make an adjustment when using the OSD. Also acts as a hot key for Brightness and Contrast adjustment.

To manually adjust the image:

1. Display the adjustment test pattern. This is the best way to observe changes as you adjust the image. Windows users should run the Auto.exe test pattern program. For non-Windows operating systems, you also can use the test pattern described in the previous section or another full-screen image, such the desktop of the operating system.
2. Open the OSD menu by pressing the **Enter** button on the monitor.
3. Turn the wheel to select the Geometry submenu and then press **Enter**.
4. Five patterns will be shown at the top of the OSD window. Use the wheel to select **Clock** and then press **Enter**.
5. Check the current setting. Use the wheel to tune the sampling clock to get the optimum picture. Look at the centre section of the test pattern that has alternating black and white vertical lines that are each 1 pixel wide. There should be no vertical noise bands visible within the image.

The centre section will clearly show the alternating black and white lines or a uniform level of noise will appear across the image. Close the clock submenu by pressing **Exit**.

6. Use the wheel to select **Horizontal Position** and press **Enter**.
7. Adjust the horizontal position so that the image is centered. Its width should be the same as the visible width of the screen. Press **Exit**.
8. If some noise or distortion is still visible in the centre section of the test pattern, turn the wheel to select **Phase** and press **Enter**.
9. Adjust the Phase of the monitor's sampling clock by turning the wheel to optimise the displayed image. The alternating black and white lines should be clearly visible. Press **Exit**.
10. Press **Exit** twice and the OSD menu will ask you if you wish to save your changes. Select **Yes** using the wheel and press **Enter** when the **Yes** indicator turns blue.

If you are still not satisfied with the result, try repeating the procedure using a graphics signal that has a different refresh rate.

Notes:

You must use one of the factory modes. If the **AUTO** button is not working, or the **NON PRESET MODE** message is shown on the OSD you are not using one of the supported modes. If you are having difficulties generating a supported mode, ask your computer dealer or the distributor or manufacturer of your graphics card for assistance.

The procedures described in this chapter should be performed for every resolution and type of graphics signal that you wish to use. For example, if a particular application requires a resolution of 800 x 600 pixels, but all other applications use the monitor's native resolution, you will need to display the test pattern and make adjustments twice.

The monitor will remember your settings and use them whenever you turn the monitor on. Note that you may need to readjust the monitor if it is connected to a different computer or if the computer's graphics adaptor is replaced.

8 Security Lock Installation

The Diamond View DV156 can be secured to your desk or any other fixed object with a Kensington lock security product. The Kensington lock's cable can be attached to a slot located at the rear of the monitor.

1. Insert the lock in the slot located on the rear of the monitor.
2. Turn the key to lock the Security Lock.
3. Remove the key and store it in a safe place.

Note: Kensington locks are not available from Mitsubishi Electric Australia. Please contact your reseller for more information.

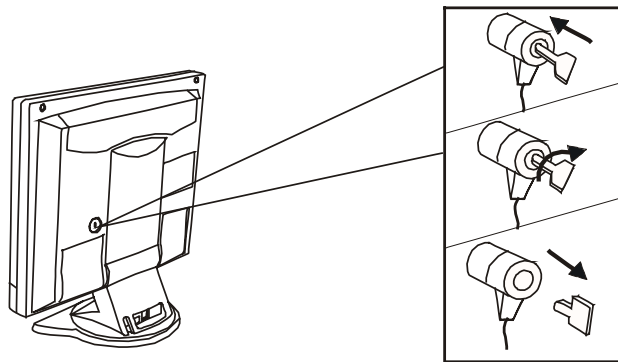

9 Frequently Asked Questions

The image is blurred, how can I get the best quality picture?

- ◆ Read chapter 6, *Setting the Display Resolution*, and select a graphics signal with the correct resolution and refresh rate. Then read chapter 7, *Adjusting the Monitor*, and make adjustments to the displayed image based on these instructions.
- ◆ Have you used a VGA extension cable?
If so, remove the extension cable and check the displayed image. Is the image quality improved? Optimise the image using the procedures in chapter 7 with the extension cable removed. Reconnect the extension cable once the image has been optimised. Depending on the characteristics and type of the extension cable, some blurring or distortion may occur due to conduction losses of the extension cable. You can minimise these losses by using an extension cable with better conduction quality or with a built-in booster.
- ◆ Does the blurring only occur at resolutions lower than the native (maximum) resolution?
Please read chapter 6, *Setting the Display Resolution*. Select a graphics signal that uses the monitor's the native resolution (1024 x 768 pixels).

Why does the image look yellow, blue or pink instead of showing the correct colours?

- ◆ The most common cause of this problem is a loose VGA signal cable or connector. Check that the cable is securely connected to the computer.
- ◆ Check the VGA signal cable for damage. If any pins are bent or broken off, contact your dealer or an authorised Mitsubishi Electric service agent (see Chapter 11 for details).
- ◆ Check the monitor's colour settings. Press the **Enter** button and use the wheel to select the Color Settings menu. Select the **Recall** menu item and press **Enter**.

No image is displayed, what can I do?

- ◆ Check that the light (LED) next to the monitor's power button is lit and is green in colour. If the LED is green, press the **Exit** button on the monitor to access the On Screen Display. If the message *NON PRESET MODE* appears there, please read chapter 6, Setting the Display Resolution and reset the graphics card to one of the monitor's supported graphics signals.
- ◆ If the LED is orange the monitor is in power saving mode. Press a button on the computer keyboard or move the mouse to wake the computer. If that does not help, check that the VGA cable is securely plugged into the computer. Also check the pins of the VGA cable's connector. If any pins are bent or broken off, then contact your dealer (see Chapter 11 for details).
- ◆ If the LED is not lit at all, check that the monitor is plugged into the power supply mains socket and that the power switch is turned on. Check that the monitor's power switch is also turned on.

The image is or distorted, flashes or flickers:

- ◆ Check that the monitor's signal cable is securely connected to the computer.
- ◆ Read the chapters 6 and 7 of this manual, then select the correct resolution, refresh rate and make adjustments based on these instructions.

The image is displaced in one direction:

- ◆ Use the **Hor. Position** (horizontal position) adjustment in the Geometry menu of the monitor's OSD to reposition the image.
- ◆ Read the chapters 6 and 7 and then select the correct resolution, refresh rate and make adjustments based on these instructions.

IO Specifications

Model **Diamond View DV156**

Display Characteristics

Display Type	15" active matrix Thin Film Transistor Liquid Crystal Display
Viewable Diagonal Area	38.1 cm / 15"
Native (Maximum) Resolution	1,024 x 768 pixels
Colours	16.7 million
Contrast Ratio	400:1 (typical)
Brightness	250 cd/m ² (typical)
Response Time	25 ms (maximum)
Viewing Angle (Horizontal, Vertical)	±80°, ±80° (typical)
Dot Pitch	0.3 mm

User Interface

Controls	Mains power switch, 2 buttons and rotary wheel to control On-Screen Display, Automatic image adjustment
On-Screen Display Functions	Contrast, Brightness, Vert. & Hor. Image Position, Phase, Pixel Clock, Color Balance, Color Palette, Choice of language (6 language OSD), OSD Position, Status Indicator
Microprocessor Controlled Graphics Modes	15 modes: 10 Preset modes, 5 User modes

Input Signal

Line Frequency	31.5 - 60.2 kHz multi-frequency
Image Frequency (Refresh Rate)	56.3 - 75.0 Hz Within the parameters detailed in chapter 6
Video Signal	RGB analog (Positive polarity) 0.7 Vpp/75 Ohm
Synchronisation	TTL separate, composite TTL
Signal Connection	15-pin mini D-sub cable

Physical Characteristics

Power Management	VESA DPMS, Energy Star
Maximum Power Consumption	45 Watts
Power Saving Mode	< 5 Watts
Operating Voltage	Automatic switched mode power supply, 90 - 264 V, 47 - 63 Hz
Dimensions (W x H x D)	380 x 383 x 186 mm
Weight	5.8 kg
Temperature (Operating)	0°C - 40°C
Air Humidity (Operating)	20% - 85%

Regulatory Certification

Safety	IEC 950, EN 60950 (TÜV/GS) AS/NZS 60950, UL1950, PTB
EMI/EMC	CSA, FCC Class B, AS/NZS 3548, VCCI
Other	TÜV/Ergonomics, FTZ Class B, DSNF, ISO 9241-3 -7 -8, CE Mark



Service Contacts

If problems remain after checking this manual, please contact your place of purchase or contact:

Australia

Visit the Customer Support section of Mitsubishi Electric Australia's web site at

www.mitsubishi-electric.com.au

for details of your nearest Mitsubishi Electric Authorised Service Centre or contact the Service Department for your state:

New South Wales and Australian Capital Territory

348 Victoria Road
Rydalmere, NSW, 2116

Telephone: (02) 9684-7669

Fax: (02) 9684-7684

Queensland

1 / 104 Newmarket Road
Windsor, Qld, 4030

Telephone: (07) 3357-8877

Fax: (07) 3357-8488

South Australia and Northern Territory

77 Port Road
Hindmarsh, SA, 5007

Telephone: (08) 8340-0444

Fax: (08) 8340-0555

Victoria and Tasmania

4 / 303 Burwood Hwy
East Burwood, Vic, 3151

Telephone: (03) 9262-9899

Fax: (03) 9262-9850

Western Australia

5 / 329 Collier Road
Bassendean, WA, 6054

Telephone: (08) 9377-3411

Fax: (08) 9377-3499

New Zealand

Contact:

Melco New Zealand Ltd.
1 Parliament St.
Lower Hutt
Wellington

Telephone: (04) 560-9100

Fax: (04) 560-9140

Web site: www.melco.co.nz