

MITSUBISHI ELECTRIC Air-Conditioners

Mr. SLIM

PEA-RP·EA / PUHZ-RP·HA

FOR USER (FOR INSTALLER)

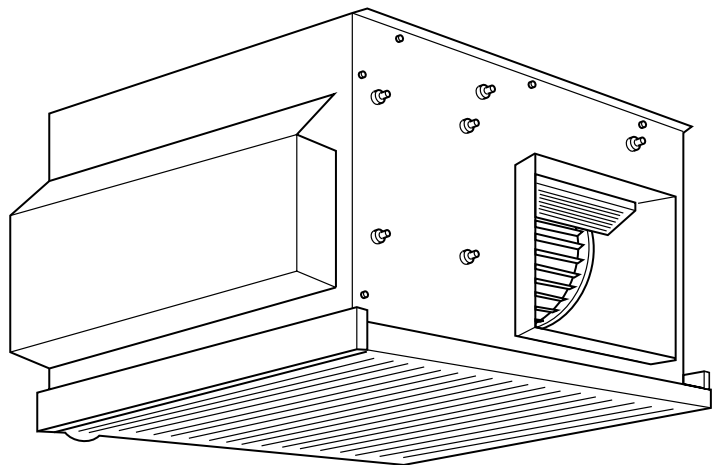

OPERATION MANUAL

For safe and correct use, please read this operation manual thoroughly before operating the air-conditioner unit.

1. Safety Precautions	2
2. Operation	3
2.1. Switching the unit on/off	3
2.2. Mode select	3
2.3. Selecting a temperature TEMP.	4
2.4. Selecting a fan speed FAN	4
2.5. Using the timer	4
3. Care and cleaning	5
3.1. Cleaning the filters and the indoor unit	5
4. Troubleshooting	6
5. Specifications	7

- ▶ Before installing the unit, make sure you read all the “Safety precautions”.
- ▶ The “Safety precautions” provide very important points regarding safety. Make sure you follow them.
- ▶ This equipment may cause the adverse effect on the same supply system.
- ▶ Please report to or take consent by the supply authority before connection to the system.

Symbols used in the text

Warning:
Describes precautions that should be observed to prevent danger of injury or death to the user.

Caution:
Describes precautions that should be observed to prevent damage to the unit.

Symbols used in the illustrations

- : Indicates an action that must be avoided.
- : Indicates that important instructions must be followed.
- : Indicates a part which must be grounded.
- : Indicates that caution should be taken with rotating parts.
- : Indicates that the main switch must be turned off before servicing.
- : Beware of electric shock.
- : Beware of hot surface.
- ELV** : At servicing, please shut down the power supply for both of Indoor Unit and Outdoor Unit.

Warning:
Carefully read the labels affixed to the main unit.

- Warning:**
- The unit should not be installed by the user. Ask the dealer or an authorized company to install the unit. If the unit is installed improperly, water leakage, electric shock or fire may result.
 - Do not stand on, or place any items on the unit.
 - Do not splash water over the unit and do not touch the unit with wet hands. An electric shock may result.
 - Do not spray combustible gas close to the unit. Fire may result.
 - Do not place a gas heater or any other open-flame appliance where it will be exposed to the air discharged from the unit. Incomplete combustion may result.

Caution:

- Do not use any sharp object to push the buttons, as this may damage the remote controller.
- Never block or cover the indoor or outdoor unit's intakes or outlets.

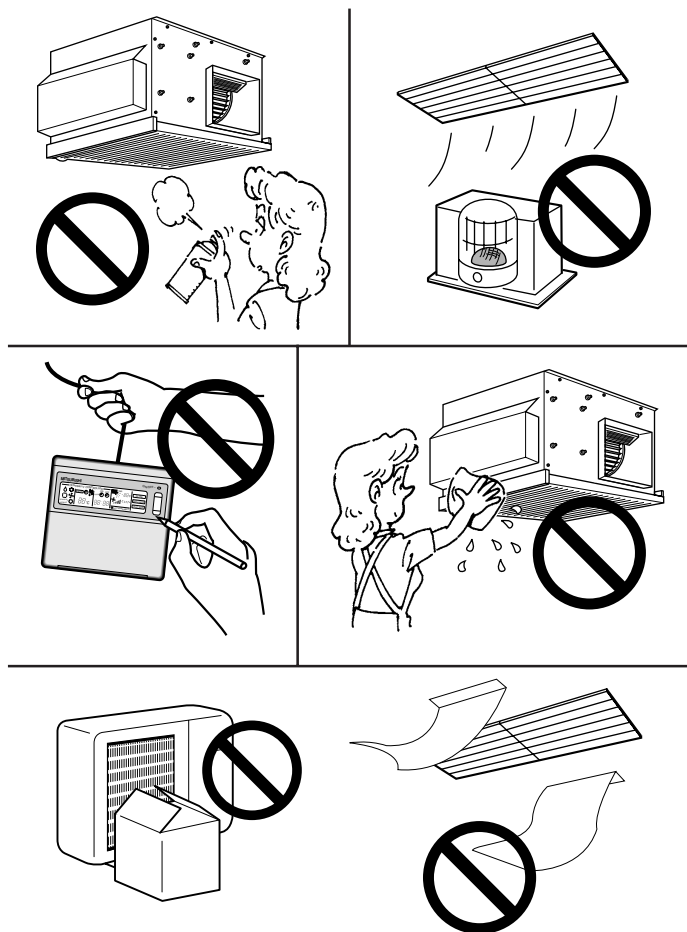

1. Safety Precautions

2. Operation

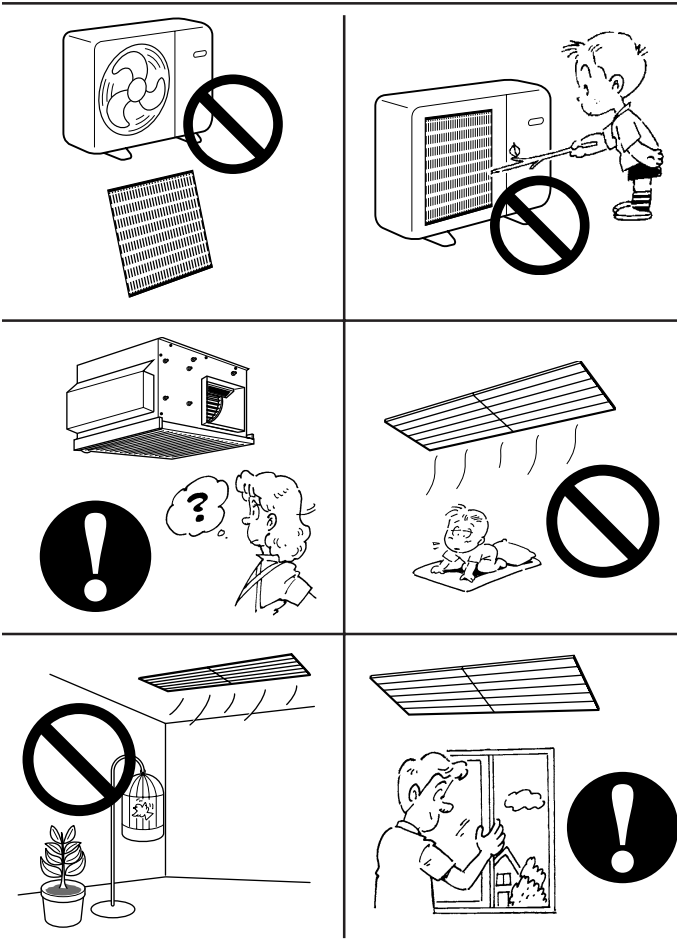

⚠ Warning:

- Do not remove the front panel or the fan guard from the outdoor unit when it is running.
- When you notice exceptionally abnormal noise or vibration, stop operation, turn off the power switch, and contact your dealer.
- Never insert fingers, sticks etc. into the intakes or outlets.
- If you detect odd smells, stop using the unit, turn off the power switch and consult your dealer. Otherwise, a breakdown, electric shock or fire may result.
- This air conditioner is NOT intended for use by children or infirm persons without supervision.
- Young children should be supervised to ensure that they do not play with the air conditioner.
- If the refrigeration gas blows out or leaks, stop the operation of the air conditioner, thoroughly ventilate the room, and contact your dealer.

Disposing of the unit

When you need to dispose of the unit, consult your dealer.

Check if your remote controller is the wired type or the wireless type before referring to the illustration and text for operation procedures.

2.1. Switching the unit on/off

- The power supply should not be turned off while the air conditioner is in use. This can cause the unit to break down.
 - ① Press the ON/OFF button.
 - Ⓐ The ON indicator should light up.
- Even if you press the ON/OFF button immediately after shutting down the operation in progress, the air conditioner will not start for about three minutes. This is to prevent the internal components from being damaged.
- If the operation stops due to a power failure, the unit will not automatically restart until the power has been restored. Press the ON/OFF button to restart.

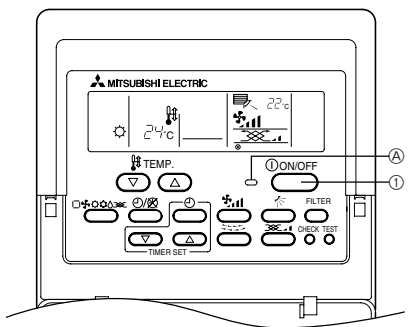

2.2. Mode select

- ① If the unit is off, press the ON/OFF button to turn it on.
 - Ⓐ The ON indicator should light up.
- ② Press the operation mode (□✪☀️💧⊞) button and select the operation mode.
 - Ⓑ
 - ☀️ Cooling mode
 - ✪ Fan mode
 - ☀️ Heating mode
 - 💧 Drying mode
 - ⊞ Automatic (cooling/heating) mode

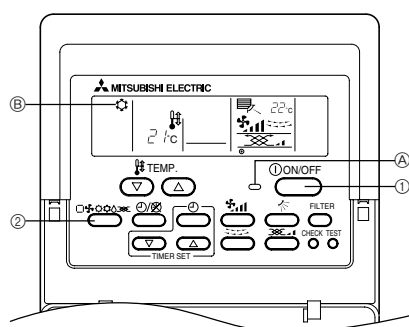

Note:

The heating display and the automatic display does not appear in models that operate exclusively as cooling only air-conditioner.

2. Operation

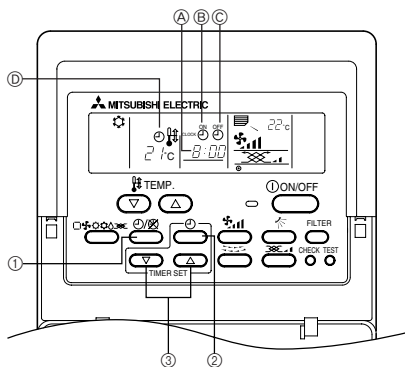
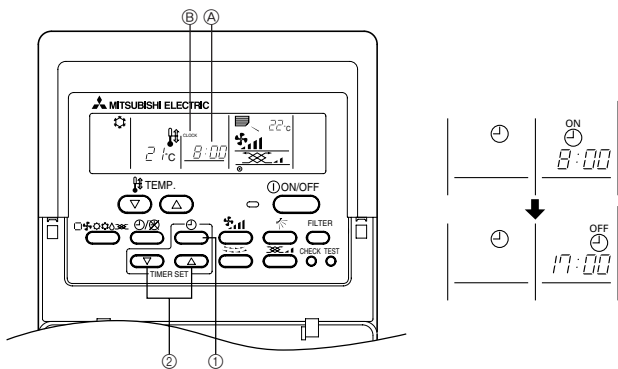
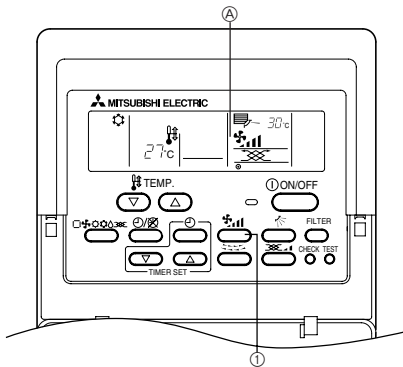
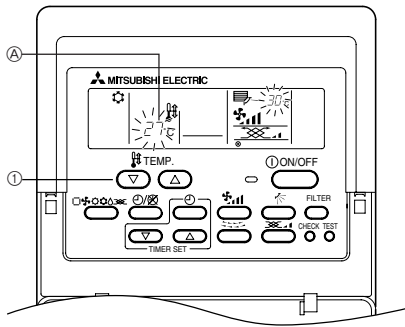

2.3. Selecting a temperature \updownarrow TEMP.

► To decrease the room temperature:

- ① Press ∇ button to set the desired temperature.
 - Ⓐ The selected temperature is displayed.
- Each time you press the button, the temperature value decreases by 1 °C.

► To increase the room temperature:

- ① Press Δ button to set the desired temperature.
 - Ⓐ The selected temperature is displayed.
- Each time you press the button, the temperature value increases by 1 °C.

• Available temperature ranges are as follows:

Cooling & Drying:	19 - 30 °C
Heating:	17 - 28 °C
Automatic:	19 - 28 °C
Circulation:	— (Not available)

- The display flashes either 8 °C - 39 °C to inform you if the room temperature is lower or higher than the displayed temperature.

2.4. Selecting a fan speed fan icon

- ① Press fan icon button to select a desired fan speed.
- Each time you press the button, available options change with the display Ⓐ on the remote controller, as shown below.

Fan speed	Remote controller display	
	Low	High
2-stage	fan icon	fan icon

The display and the fan speed of the unit will differ in the following situations:

- When STAND BY and DEFROST are displayed.
- Just after the heating mode (while waiting to change to another mode).
- When the temperature of the room is higher than the temperature setting of the unit operating in the heating mode.
- In the dry operation, the indoor fan automatically turns to low-speed operation. Switching of fan speed is impossible.

2.5. Using the timer

1) Set the current time

- ① Press clock icon button to display the "CLOCK" Ⓐ.

Remote controller display Ⓐ	CLOCK $\xrightarrow{\text{clock icon ON}}$ $\xrightarrow{\text{clock icon OFF}}$ No Display
-----------------------------	---

- ② Each time you press Δ button, the time increases in increments of one minute. Each time you press ∇ button, the time decreases in increments of one minute.
- Press and hold the button to rapidly change the time.
- The time changes in increments of one minute \rightarrow ten minutes \rightarrow in units of hour; in this order.
- Approximately ten seconds after pressing the button, the display on the remote controller will turn off.

The example shows a timer set for operation start at 8:00 and end at 17:00.

2) Set the mode to continuous as follows

- ① Press timer icon button to display timer icon Ⓐ.

3) Set the time to start the unit as follows

- ② Press clock icon button to display Ⓑ Ⓒ.
- ③ Press timer set icon button to set the time that you want the unit to start. The start time is displayed at Ⓐ.

4) Set the time to stop the unit as follows

- ② Press clock icon button to display Ⓒ Ⓓ.
- ③ Press timer set icon button to set the time that you want the unit to stop. The stop time is displayed at Ⓐ.

5) Set the mode to timer as follows

- ① Press timer icon button to display timer icon Ⓐ.

3. Care and cleaning

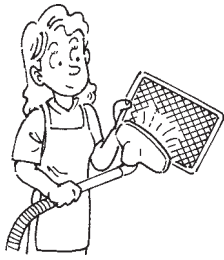

3.1. Cleaning the filters and the indoor unit

Cleaning the filters

- Clean the filters using a vacuum cleaner. If you do not have a vacuum cleaner, tap the filters against a solid object to knock off dirt and dust.
- If the filters are especially dirty, wash them in lukewarm water. Take care to rinse off any detergent thoroughly and allow the filters to dry completely before putting them back into the unit.

⚠ Caution:

- Do not dry the filters in direct sunlight or by using a heat source, such as an electric heater: this may warp them.
- Do not wash the filters in hot water (above 50°C), as this may warp them.
- Make sure that the air filters are always installed. Operating the unit without air filters can cause malfunction.

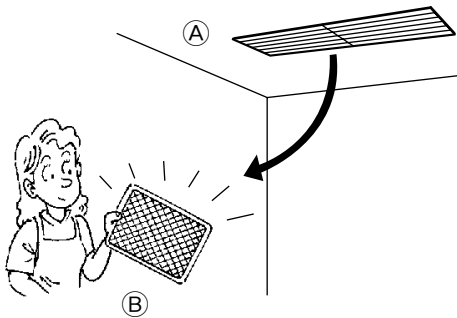

⚠ Caution:

- Before you start cleaning, stop operation and turn OFF the power supply.
- The air filter should be obtained locally. Be sure to check on the location and the way of setting with the contractor when the unit perform a trial run. (Example) The air filter should be attached to the indoor unit's air intake (rear side of unit).

- Ⓐ Air intake
- Ⓑ Filter

4. Troubleshooting

Before you call out a repair man, check the following table to see whether there is a simple solution to your problem.

[for wired remote controller]

Problem	Solution	Problem	Solution
Unit does not cool or heat very well.	Clean the filter.	CENTRALLY CONTROLLED is displayed in the remote controller.	The start and stop functions of the remote controller are not available when the CENTRALLY CONTROLLED message is lit.
The unit stops operating before arriving at the set temperature in the heating mode.	Frost forms when the outdoor temperature is low and humidity is high. Wait for about 10 minutes for the frost to melt.	The start and stop functions are not available just after restarting the unit.	Wait about three minutes (operation has stopped to prevent damage to the air conditioner).
A white mist is expelled from the indoor unit.	This may occur just after the unit is turned on when a high level of humidity is present in the room.	"H0" is displayed in the remote controller.	An automatic startup test is being performed (will last for about two minutes).
The indicators of the remote controller do not light up when operated.	Turn on the power switch. ". ." will be displayed.	An error code is displayed in the remote controller. The operating display of the wireless remote controller's receiver is flashing.	A self-diagnostic function is being performed to preserve the air conditioner. * Do not attempt to make repairs yourself. Turn the main switch off and contact the dealer from whom you bought the air conditioner. Provide him or her with the name of the unit and the information displayed in the remote controller.

NOTE: After a power cut, the unit will not restart automatically. You will have to restart it by pressing the POWER - ON/OFF button on the remote controller.

If none of the above apply, turn the main switch off and contact the dealer from whom you bought the air-conditioner, telling him the model name and the nature of the problem. Do not try to fix the unit yourself.

In any of the following cases, turn off the main power switch and contact your local dealer for service:

- The operation lamp (on the main unit) flashes.
- The switches do not work properly.
- The circuit breaker trips frequently (or the fuse blows frequently).
- Water has accidentally been splashed into the unit.
- Water leaks from the unit.
- Something is accidentally dropped into the air-conditioner.
- An unusual noise is heard during operation.

Operating range

		Indoor air intake temperature	Outdoor air intake temperature
Cooling	Maximum	35 °C DB, 22.5 °C WB	46 °C DB
	Minimum	19 °C DB, 15 °C WB	-5 °C DB
Heating	Maximum	28 °C DB	21 °C DB, 15 °C WB
	Minimum	17 °C DB	-11 °C DB, -12 °C WB

The following do not indicate any malfunction:

Odours: smells such as tobacco or cosmetic odours may persist after they have been sucked into the unit.

Sound of liquid flowing inside indoor unit: this can occur during or after operation and is simply the sound of refrigerant being circulated inside the unit.

Ticking sound coming from indoor unit: this can occur when cooling or heating has just begun or has just stopped. It is caused by the indoor unit shrinking or expanding slightly due to the change in temperature.

The message "CENTRALLY CONTROLLED" appearing on the LCD panel: from time to time, this message may come up on the LCD panel. This does not indicate any malfunction.

NOTE: The refrigerant charged in the air conditioner is safe. Refrigerant normally does not leak, however, if refrigerant gas leaks indoors, and comes into contact with the fire of a fan heater, space heater, stove, etc., harmful substances will be generated.
Be sure to ask the service representative whether there is refrigerant leakage or not when repairs are carried out.

5. Specifications

■ PEA-RP-EA + PUAZ-RP-VHA

Model		RP3	RP4	RP5	RP6
Capacity (Cooling/Heating) *1	<kW>	7.10/8.00	10.00/11.20	12.50/14.00	14.00/16.00
Total Input (Cooling/Heating) *1	<kW>	2.48/2.47	3.25/3.20	4.42/4.30	5.03/4.73
Power source (voltage <V>/Frequency <Hz>)		-			
Dimension	Height <mm>	428	428	428	428
	Width <mm>	785	1055	1055	1415
	Depth <mm>	690	690	690	690
Fan Airflow rate (Low-High)	<m ³ /min>	22-27	27-34	34-42	48-60
External static pressure	<Pa>	125	125	125	125
Noise level (Low-High)	<dB>	52-55	54-58	54-58	51-55
Net weight	<kg>	46	58	72	73

*1 Cooling: Indoor 27 °CDB/19 °CWB, Outdoor 35 °CDB
 Heating: Indoor 20 °CDB, Outdoor 7 °CDB/6 °CWB

■ PUAZ-RP-VHA

Model		RP3	RP4	RP5	RP6
Power source (voltage <V>/Frequency <Hz>)		V:~N 220-230-240/50			
Dimension	Height <mm>	943		1350	
	Width <mm>		950		
	Depth <mm>		330+30		
Fan Airflow rate	<m ³ /min>	55		100	
Net weight	<kg>	75		121	

Please be sure to put the contact address/telephone number on
this manual before handing it to the customer.